

LAD 列安达广告
8517/8588/859 0757-83789456



CHUNMEI 2019 新品推介手册
PRODUCTS CATALOGUE
纯美
Glass Hardware Accessories 玻璃五金配件系列



高要區金利鎮現代五金製品廠
GAOYAO DISTRICT JINLI TOWN MODERN HARDWARE MANUFACTORY
廠址：廣東省肇慶市高要區金利鎮金盛工業園
Address: No.18 Jin Can North Road, Jinsheng Industrial Park, Jinli Town, Gaoyao District, Zhaodu City, Guangdong Province, China
電話 (TEL) : +86-758-8598318 / 8596363
傳真 (FAX) : +86-758-8598836
網址: www.gyxdwj.com 郵箱: 1282620688@qq.com
E-mail: admin@modernchunmei.com
carman@modernchunmei.com
Skype: modern.china

純美國際 (香港) 實業有限公司
CHUNMEI INT'L (HK) LIMITED
香港辦公室：中國香港九龍官興業街14-16號永興工業塔樓6樓C-1-D
HK Office: C-1-D, 6/F, Wing Hing Industrial Building, 14-16 Hing YIP ST, Kwun tong, Kowloon Hongkong, China



Chunmei
The experts of
high quality
Hardware

純美
高品質五金專家

We are committed to serve engineering users, commercial users, personal consumption and other types of users.

We are the professional model for many years and have a creative spirit.

We are dedicated to the user subdivision and meet the personalized demand.

Our greatest wish is to make customers satisfied.

We are provided with a first-class production technology, standardized production, creative design and effective control of quality management.

We enable your life to be more comfortable, fashionable and safer with the expert quality.

我们致力服务工程用户、商用用户、个人消费等各类用户

以多年的专业典范，创意精神

执着于用户细分，满足着个性化的需求

我们最大的心愿是尽力使用户满意

一流的生产技术、标准化的生产、创意的设计及质量管理的有效控制

以专家的品质使您的生活更舒适、时尚、安全



chunmei[®]
cm 純美

高要市金利鎮現代五金制品廠
GAOYAO JINLI MODERN HARDWARE MANUFACTORY



Chunmei Brief introduction of the enterprise

純美 企業簡介

纯美企业是一家专业生产工程配件五金等产品的制造商。拥有先进、高效、严谨的管理模式，精良的生产设备，一流的技术力量，确保了我们能准时生产制造出优质的产品；高素质的商务队伍，完善的营销网络，确保了我们为客户提供优质的售前、售中和售后服务。

在管理方面，全面执行规范化的国际质量管理标准，务求使产品达到“方便、实用、高品质”的要求，确立了“产品专业化、生产规模化”的经营方针。经过了多年的不懈努力，纯美企业已具备强大的生产能力，产品齐全，品质卓越。

多年来，纯美企业一直本着“以品质创品牌，用品牌占市场，让信誉和服务去延续市场”的经营理念，且得到广大商家的好评。使我们在激烈的市场竞争中立于不败之地。

您的支持，是纯美企业发展的源泉，我们将一如既往地坚持以质量为本的宗旨，不遗余力去开拓创新，忠诚与广大客户真诚携手合作，共同发展，开创未来。

Chunmei Enterprise is a professional manufacturer of project fitting hardware and so on. It has advanced, efficient and stringent management mold and excellent manufacturing facilities and first-class technical force, which means that we can manufacture quality products in time. Our qualified business team, perfect marketing networks enables us to provide customers with quality before-sales, in-sales and after-sales services.



In the respect of management, we fully carry out standardized international quality management standard, striving to meet the requirements of "convenience, practicality and high quality". Besides, We have established the business policy of "professional products and large-scale production". Through years of unremitting efforts, our enterprise has had powerful production capacity, resulting in complete product lines and superior product quality.



For many years, Chunmei has been pursuing to marketing policy of "building brand on quality, occupying the market with brand, and keeping the market with reputation and service", winning high praises of the customers. Therefore we have remained invincible in the severe market competition .

Your support is the source for the development of Chunmei Enterprise. We will, as always, keep on with our basic principle of relying quality, and make unremitting efforts to pioneer and innovate, and sincerely cooperate with customers for mutual development and for a wonderful future.

MODERN HARDWARE MANUFACTORY

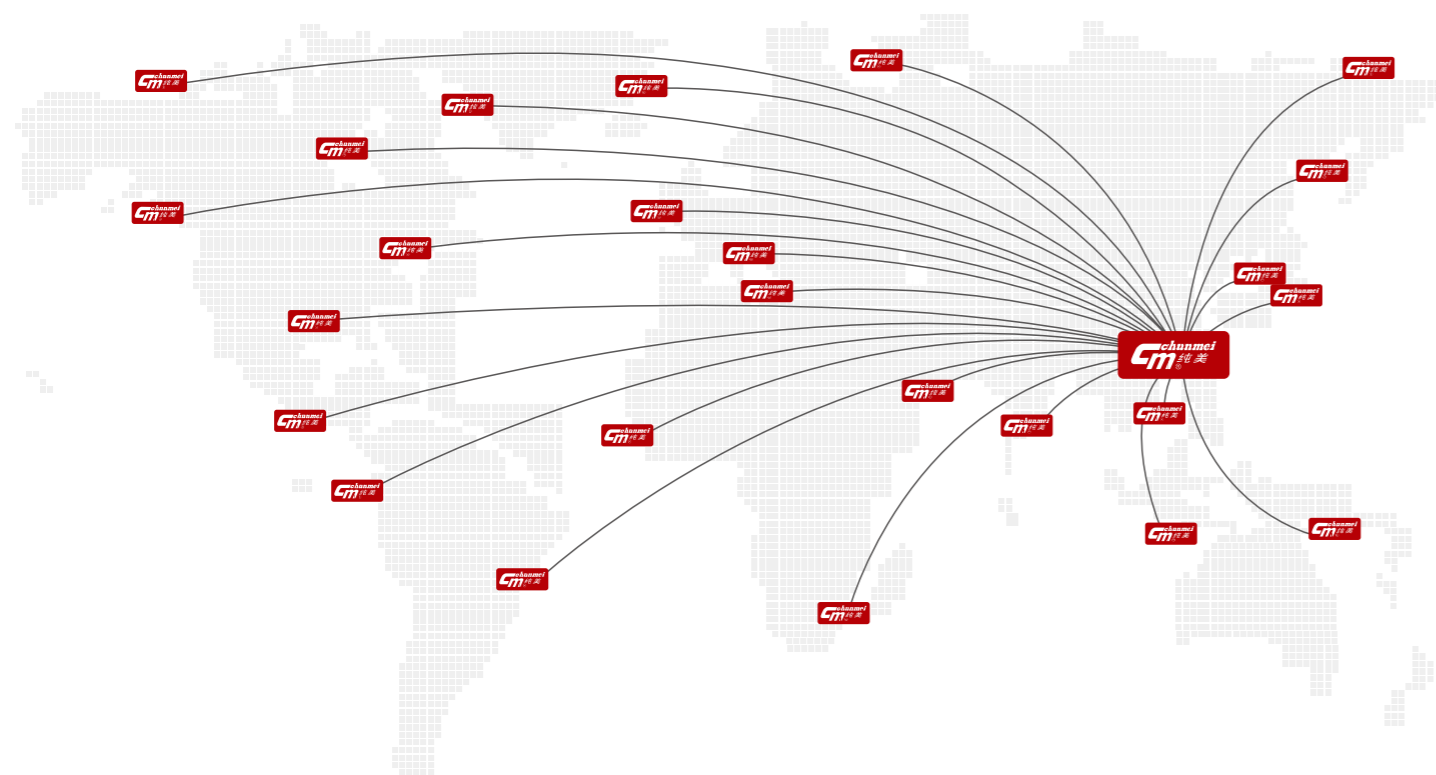

Chunmei
Let the metals all
over the
World
純美
讓五金遍布世界

完善的銷售網絡 PERFECT SALES NETWORKS

用消費者的信用和多年的努力以及企業本身的品質，建立的銷售網絡遍及全國各地，延展世界各處。
With consumer credit and many years of efforts and the quality of the enterprise itself, to establish a sales network throughout the country, extending throughout the world.

體貼的售後服務 ATTENTIVE AFTER-SALES SERVICES

我們的客戶服務人員，遍布于全國各個區域，能够鑒于對產品功能特性，客戶實際要求，市場現狀的分析，快速處理大小事務，第一時間為你提供周全的高素質營銷服務。
We have customer-service staff in every district of the country. According to product conditions, customer requirements, and market situations, they will do quick analysis, give exact solutions and offer close services.

Chunmei
Strength to witness
the
future
純美
實力見證未來



現代化倉儲物流體系，更便捷 更及時

經過多年的悉心經營和穩步提升，純美建立了一整套成熟而高效的物流網絡和完善的服務體系，公司產品觸覺遍布國內外，產品庫存充裕而科學，可以更好地服務客戶的實際需要，為客戶的發展提供最有力的支撐。

Through years of scrupulous operation and steady development, Chunmei has established a set of mature and high-efficient logistics network and perfect service system. The company's products is found at home and abroad, and the product inventory is abundant and scientific, which can serve the actual needs of customers in an even better fashion and provide powerful support for the development of customers.



20 More than 20 alliance and cooperative logistics enterprises
多家联盟合作物流企业

2000m² 2000m² logistics transshipment depot
物流中转仓库

800 Inventory of more than 800 conventional products
多种常规产品库存

2 2 distribution motorcades
支自有配送车队

Create their own
unique brand image

Chunmei

純美
打造自己獨特的品牌形象

在当今五金行业产品同质化非常严重的环境下，如何打造自己独特的品牌形象，让纯美五金从众多五金品牌中脱颖而出？这一直纯美人思考的问题。这种思考贯穿品牌塑造的整个过程，并作为一个根本方略，指导整个生产和销售过程。只有不断思考，才能为品牌注入更深刻的思想内涵，才能形成差异化的竞争优势。

创新是品牌的灵魂，是提高品牌核心竞争力的主要手段。纯美五金以创新为发展之本，强化产品设计开发，努力创新产品研发、生产技术、不断推出科技含量高、引领市场潮流的新品。同时积极深化品牌经营管理，不断推动企业强势健康发展。

共赢是 21 世纪企业国际化战略的趋势，共赢的基础是优势互补；共赢的方式是资源互换，共赢的结果是共同发展。共赢，体现着纯美五金的卓然气度，更体现着纯美的高瞻远瞩。

In the current environment that product homogenization in hardware industry is quite serious, how to create unique brand image to make Chunmei hardware stands out from numerous hardware brands? This is always the problem that thought by Chunmei staffs. This thinking runs through the whole process of brand building and guides the whole production and sales process as a fundamental strategy. Only through ceaselessly thinking can one inject more profound thought connotation into brand and form differential competitive advantage.















Innovation is the soul of brand and the main method for improving core competitiveness of brand. Chunmei hardware considers innovation as its development basis, strengthens product design and development, strives to create product research, production technology and continuously brings out new products that have high technological content and lead the market trend. At the same time, it positively deepens brand operation and management and ceaselessly promotes strong and health development of enterprise.

Win-win is the trend of enterprise internationalization strategy of 21 century. The foundation of win-win is making their respective advantages complementary to each other; the method of win-win is resource exchange and the result of win-win is mutual development. Win-win not only reflects remarkable disposition of Chunmei hardware, but also reflects foresight vision of Chunmei.

chunmei[®]
m 純美

CATALOGUE

純美產品目錄

	A 玻璃栏杆夹系列 Glass railing clamp series	1-8
	B 固定玻璃夹系列 Fixed glass clip series	9-20
	C 管托 / 吊码系列 Tube support series	21-34
	D 层板托系列 Shelf support series	35-38
	E 广告钉系列 Advertising screw series	39-42
	F 线盒系列 Line box series	43-48
	G 气撑系列 Gas spring series	49-58
	H 反弹器系列 Push open system	59-60
	I 浴室夹系列 Partition hinge series	61-68
	J 隔断码系列 Partition hinge series	70-72
	K 支撑架系列 Support frame series	73-74
	L 玻璃合页系列 Glass hinge series	75-78
	M 浴室小拉手系列 Bathroom handle series	79-80
	N 镜钉系列 Mirror nail series	81-82
	O 橱柜拉手和挂钩系列 Cabinet handle and Hook series	83-90



CM 146

薄装弧底 /Light Style Around Bottom
玻璃厚度: 6-8mm
Glass thickness: 6-8mm

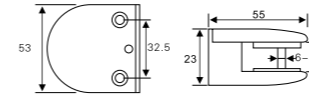

CM 146-1

薄装平底 /Light Style Flat Bottom
玻璃厚度: 6-8mm
Glass thickness: 6-8mm

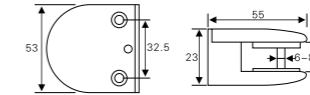

- 材质: 锌合金
Material: Zinc alloy
- 表面处理: 光络、拉丝镍、仿金、珍珠络、珍珠镍、红古铜、青古铜、枪黑
Finish: Chrome, Brush Nickel-Golden, Matt Chrome, Peal Nickel, Bronze, Green bronze, Lance Black
- 适用范围: 玻璃层板
Available For: Glass shelf



CM 147

弧底 /Around Bottom
玻璃厚度: 6-8mm
Glass thickness: 6-8mm

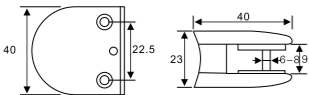

CM 147-1

平底 /Flat Bottom
玻璃厚度: 6-8mm
Glass thickness: 6-8mm

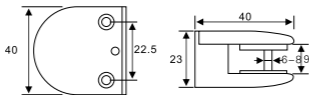

- 材质: 锌合金
Material: Zinc alloy
- 表面处理: 光络、拉丝镍、仿金、珍珠络、珍珠镍、红古铜、青古铜、枪黑
Finish: Chrome, Brush Nickel-Golden, Matt Chrome, Peal Nickel, Bronze, Green bronze, Lance Black
- 适用范围: 玻璃层板
Available For: Glass shelf



CM 148-1

厚装弧底 /Heavy Style Around Bottom
玻璃厚度: 6-8mm
Glass thickness: 6-8mm

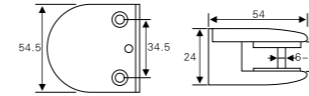

CM 150-1

厚装平底 /Heavy Style Flat Bottom
玻璃厚度: 6-8mm
Glass thickness: 6-8mm

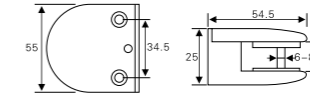

- 材质: 锌合金
Material: Zinc alloy
- 表面处理: 光络、拉丝镍、仿金、珍珠络、珍珠镍、红古铜、青古铜、枪黑
Finish: Chrome, Brush Nickel-Golden, Matt Chrome, Peal Nickel, Bronze, Green bronze, Lance Black
- 适用范围: 玻璃层板
Available For: Glass shelf



CM 148

弧底 /Around Bottom
玻璃厚度: 6-8mm
Glass thickness: 6-8mm

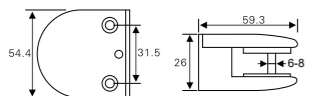

CM 150

平底 /Flat Bottom
玻璃厚度: 6-8mm
Glass thickness: 6-8mm

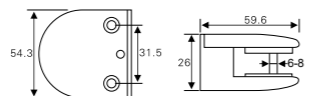

- 材质: 锌合金
Material: Zinc alloy
- 表面处理: 光络、拉丝镍、仿金、珍珠络、珍珠镍、红古铜、青古铜、枪黑
Finish: Chrome, Brush Nickel-Golden, Matt Chrome, Peal Nickel, Bronze, Green bronze, Lance Black
- 适用范围: 玻璃层板
Available For: Glass shelf



CM 148A

玻璃厚度: 12-15mm
Glass thickness: 12-15mm

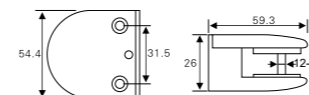

CM 150A

玻璃厚度: 12-15mm
Glass thickness: 12-15mm

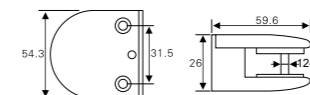

- 材质: 锌合金
Material: Zinc alloy
- 表面处理: 光络、拉丝镍、仿金、珍珠络、珍珠镍、红古铜、青古铜、枪黑
Finish: Chrome, Brush Nickel-Golden, Matt Chrome, Peal Nickel, Bronze, Green bronze, Lance Black
- 适用范围: 玻璃层板
Available For: Glass shelf



CM 152

小号弧底 / Small Around Bottom
玻璃厚度: 8-10mm
Glass thickness: 8-10mm

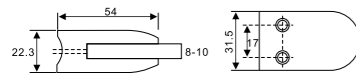

CM 152-1

小号平底 / Small Flat Bottom
玻璃厚度: 8-10mm
Glass thickness: 8-10mm

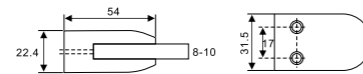

- 材质: 锌合金
Material: Zinc alloy
- 表面处理: 光络、拉丝镍、仿金、珍珠络、珍珠镍、红古铜、青古铜、枪黑
Finish: Chrome、Brush Nickel-Golden、Matt Chrome、Peal Nickel、Bronze、Green bronze、Lance Black
- 适用范围: 玻璃层板
Available For: Glass shelf



CM 873

玻璃厚度: 4-6mm
Glass thickness: 4-6mm

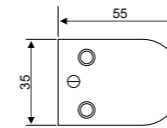

CM 874

玻璃厚度: 4-6mm
Glass thickness: 4-6mm

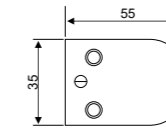

- 材质: 不锈钢
Material: Stainless steel
- 表面处理: 拉丝、亮光
Finish: Satin、Polish
- 适用范围: 玻璃层板
Available For: Glass shelf



CM 153

大号弧底 / Large Around Bottom
玻璃厚度: 10-12mm
Glass thickness: 10-12mm

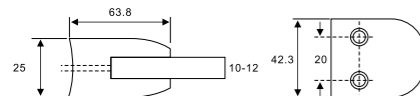

CM 153-1

大号平底 / Large Flat Bottom
玻璃厚度: 10-12mm
Glass thickness: 10-12mm

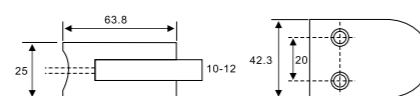

- 材质: 锌合金
Material: Zinc alloy
- 表面处理: 光络、拉丝镍、仿金、珍珠络、珍珠镍、红古铜、青古铜、枪黑
Finish: Chrome、Brush Nickel-Golden、Matt Chrome、Peal Nickel、Bronze、Green bronze、Lance Black
- 适用范围: 玻璃层板
Available For: Glass shelf



CM 867

玻璃厚度: 6-8mm
Glass thickness: 6-8mm

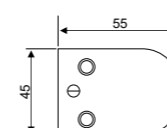

CM 868

玻璃厚度: 6-8mm
Glass thickness: 6-8mm

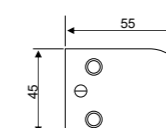

- 材质: 不锈钢
Material: Stainless steel
- 表面处理: 拉丝、亮光
Finish: Satin、Polish
- 适用范围: 玻璃层板
Available For: Glass shelf



CM 151

方形弧底 / Around Bottom
玻璃厚度: 6-8mm
Glass thickness: 6-8mm

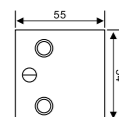

CM 151-1

方形平底 / Flat Bottom
玻璃厚度: 6-8mm
Glass thickness: 6-8mm

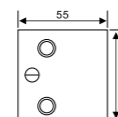

- 材质: 不锈钢
Material: Stainless steel
- 表面处理: 拉丝、亮光
Finish: Satin、Polish
- 适用范围: 玻璃层板
Available For: Glass shelf



CM 869

玻璃厚度: 10-12mm
Glass thickness: 10-12mm

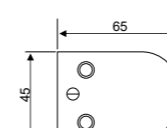

CM 870

玻璃厚度: 10-12mm
Glass thickness: 10-12mm

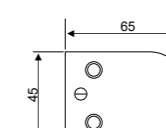

- 材质: 不锈钢
Material: Stainless steel
- 表面处理: 拉丝、亮光
Finish: Satin、Polish
- 适用范围: 玻璃层板
Available For: Glass shelf



CM 877

玻璃厚度: 10-12mm
Glass thickness: 10-12mm

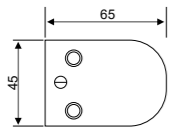

CM 878

玻璃厚度: 10-12mm
Glass thickness: 10-12mm

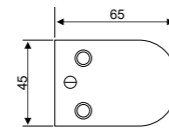

-  材质: 不锈钢
Material: Stainless steel
-  表面处理: 拉丝、亮光
Finish: Satin, Polish
-  适用范围: 玻璃层板
Available For: Glass shelf



CM 866

平底 / Flat Bottom
玻璃厚度: 8-10mm
Glass thickness: 8-10mm

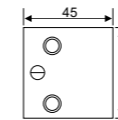

CM 866-1

弧底 / Around Bottom
玻璃厚度: 8-10mm
Glass thickness: 8-10mm

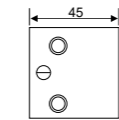

-  材质: 不锈钢
Material: Stainless steel
-  表面处理: 拉丝、亮光
Finish: Satin, Polish
-  适用范围: 玻璃层板
Available For: Glass shelf



CM 875

玻璃厚度: 10-12mm
Glass thickness: 10-12mm

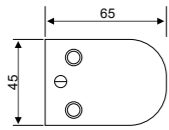

CM 876

玻璃厚度: 10-12mm
Glass thickness: 10-12mm

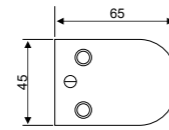

-  材质: 不锈钢
Material: Stainless steel
-  表面处理: 拉丝、亮光
Finish: Satin, Polish
-  适用范围: 玻璃层板
Available For: Glass shelf



CM 883

玻璃厚度: 8-10mm
Glass thickness: 8-10mm

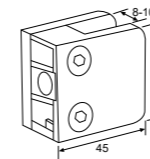

CM 884

玻璃厚度: 8-10mm
Glass thickness: 8-10mm

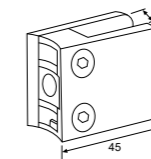

-  材质: 不锈钢
Material: Stainless steel
-  表面处理: 拉丝、亮光
Finish: Satin, Polish
-  适用范围: 玻璃层板
Available For: Glass shelf



CM 881

玻璃厚度: 10-12mm
Glass thickness: 10-12mm

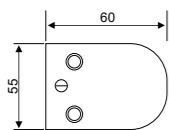

CM 882

玻璃厚度: 10-12mm
Glass thickness: 10-12mm

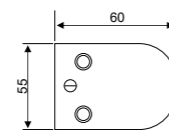

-  材质: 不锈钢
Material: Stainless steel
-  表面处理: 拉丝、亮光
Finish: Satin, Polish
-  适用范围: 玻璃层板
Available For: Glass shelf



CM-R052

玻璃厚度: 8-12mm
Glass thickness: 8-12mm

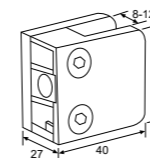

CM-R052B

玻璃厚度: 8-12mm
Glass thickness: 8-12mm

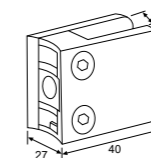

-  材质: 精铸不锈钢
Material: Casting stainless steel
-  表面处理: 拉丝、亮光
Finish: Satin, Polish
-  适用范围: 玻璃层板
Available For: Glass shelf



CM-R053

玻璃厚度: 8-12mm
Glass thickness: 8-12mm

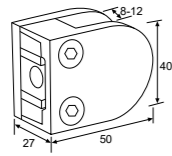

CM-R053B

玻璃厚度: 8-12mm
Glass thickness: 8-12mm

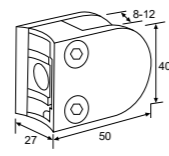

-  材质: 精铸不锈钢
Material: Casting stainless steel
-  表面处理: 拉丝、亮光
Finish: Satin、Polish
-  适用范围: 玻璃层板
Available For: Glass shelf



CM-R056

玻璃厚度: 8-10mm
Glass thickness: 8-10mm

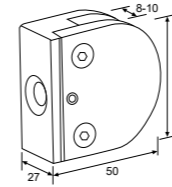

CM-R056B

玻璃厚度: 8-10mm
Glass thickness: 8-10mm

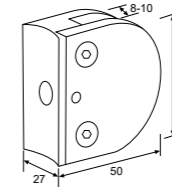

-  材质: 精铸不锈钢
Material: Casting stainless steel
-  表面处理: 拉丝、亮光
Finish: Satin、Polish
-  适用范围: 玻璃层板
Available For: Glass shelf



CM-R054

玻璃厚度: 8-12mm
Glass thickness: 8-12mm

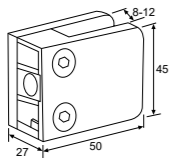

CM-R054B

玻璃厚度: 8-12mm
Glass thickness: 8-12mm

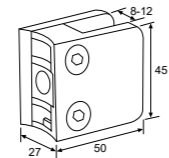

-  材质: 精铸不锈钢
Material: Casting stainless steel
-  表面处理: 拉丝、亮光
Finish: Satin、Polish
-  适用范围: 玻璃层板
Available For: Glass shelf



CM-R057

玻璃厚度: 8-10mm
Glass thickness: 8-10mm

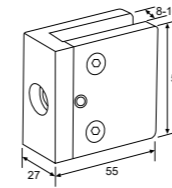

CM-R057B

玻璃厚度: 8-10mm
Glass thickness: 8-10mm

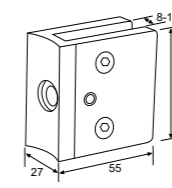

-  材质: 精铸不锈钢
Material: Casting stainless steel
-  表面处理: 拉丝、亮光
Finish: Satin、Polish
-  适用范围: 玻璃层板
Available For: Glass shelf



CM-R055

玻璃厚度: 8-12mm
Glass thickness: 8-12mm

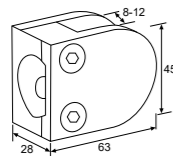

CM-R055B

玻璃厚度: 8-12mm
Glass thickness: 8-12mm

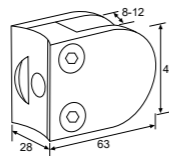

-  材质: 精铸不锈钢
Material: Casting stainless steel
-  表面处理: 拉丝、亮光
Finish: Satin、Polish
-  适用范围: 玻璃层板
Available For: Glass shelf



CM-R058

玻璃厚度: 8-12mm
Glass thickness: 8-12mm

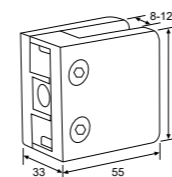

CM-R058B

玻璃厚度: 8-12mm
Glass thickness: 8-12mm

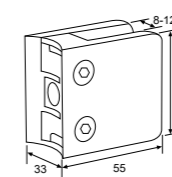

-  材质: 精铸不锈钢
Material: Casting stainless steel
-  表面处理: 拉丝、亮光
Finish: Satin、Polish
-  适用范围: 玻璃层板
Available For: Glass shelf



CM 100-8
玻璃厚度: 6-8mm
Glass thickness: 6-8mm

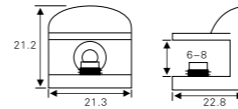

CM 100-10
玻璃厚度: 8-10mm
Glass thickness: 8-10mm

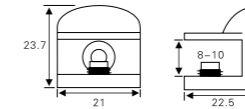

CM 101
玻璃厚度: 10-12mm
Glass thickness: 10-12mm

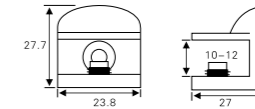

- 材质: 锌合金
Material: Zinc alloy
- 表面处理: 光络、拉丝镍、仿金、珍珠络、珍珠镍、红古铜、青古铜、枪黑
Finish: Chrome, Brush Nickel-Golden, Matt Chrome, Peal Nickel, Bronze, Green bronze, Lance Black
- 适用范围: 玻璃层板、木层板
Available For: Glass shelf and wooden plywood



CM 102-8
玻璃厚度: 6-8mm
Glass thickness: 6-8mm

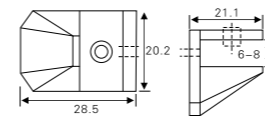

CM 102-10
玻璃厚度: 8-10mm
Glass thickness: 8-10mm

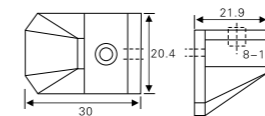

CM 103
玻璃厚度: 10-12mm
Glass thickness: 10-12mm

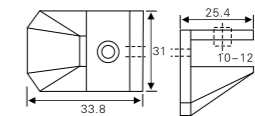

- 材质: 锌合金
Material: Zinc alloy
- 表面处理: 光络、拉丝镍、仿金、珍珠络、珍珠镍、红古铜、青古铜、枪黑
Finish: Chrome, Brush Nickel-Golden, Matt Chrome, Peal Nickel, Bronze, Green bronze, Lance Black
- 适用范围: 玻璃层板、木层板
Available For: Glass shelf and wooden plywood



CM 104-6
玻璃厚度: 5-6mm
Glass thickness: 5-6mm

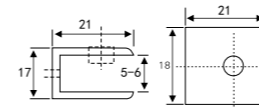

CM 104-7
玻璃厚度: 5-7mm
Glass thickness: 5-7mm

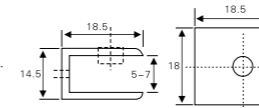

CM 104-8
玻璃厚度: 6-8mm
Glass thickness: 6-8mm

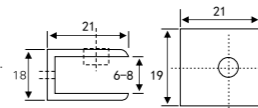

CM 104-10
玻璃厚度: 8-10mm
Glass thickness: 8-10mm

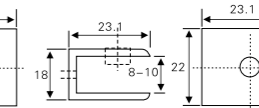

CM 105
玻璃厚度: 10-12mm
Glass thickness: 10-12mm

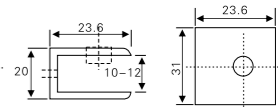

- 材质: 锌合金
Material: Zinc alloy
- 表面处理: 光络、拉丝镍、仿金、珍珠络、珍珠镍、红古铜、青古铜、枪黑
Finish: Chrome, Brush Nickel-Golden, Matt Chrome, Peal Nickel, Bronze, Green bronze, Lance Black
- 适用范围: 玻璃层板、木层板
Available For: Glass shelf and wooden plywood



CM 106-8

玻璃厚度: 6-8mm
Glass thickness: 6-8mm

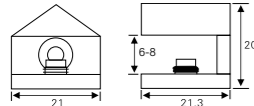

CM 106-10

玻璃厚度: 8-10mm
Glass thickness: 8-10mm

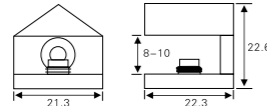

CM 107

玻璃厚度: 10-12mm
Glass thickness: 10-12mm

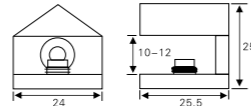

- 材质: 锌合金
Material: Zinc alloy
- 表面处理: 光络、拉丝镍、仿金、珍珠络、珍珠镍、红古铜、青古铜、枪黑
Finish: Chrome, Brush Nickel-Golden, Matt Chrome, Peel Nickel, Bronze, Green bronze, Lance Black
- 适用范围: 玻璃层板、木层板
Available For: Glass shelf and wooden plywood



CM 112

玻璃厚度: 6mm
Glass thickness: 6mm

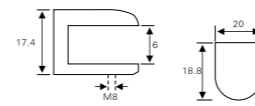

CM 113

玻璃厚度: 8mm
Glass thickness: 8mm

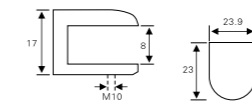

CM 117

玻璃厚度: 8mm
Glass thickness: 8mm

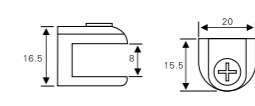

CM 117-1

玻璃厚度: 8mm
Glass thickness: 8mm

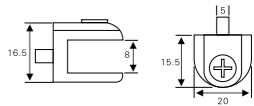

- 材质: 锌合金
Material: Zinc alloy
- 表面处理: 光络、拉丝镍、仿金、珍珠络、珍珠镍、红古铜、青古铜、枪黑
Finish: Chrome, Brush Nickel-Golden, Matt Chrome, Peel Nickel, Bronze, Green bronze, Lance Black
- 适用范围: 玻璃层板、木层板
Available For: Glass shelf and wooden plywood



CM 108-8

玻璃厚度: 6-8mm
Glass thickness: 6-8mm

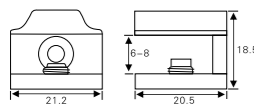

CM 108-10

玻璃厚度: 8-10mm
Glass thickness: 8-10mm

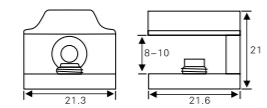

CM 109

玻璃厚度: 10-12mm
Glass thickness: 10-12mm

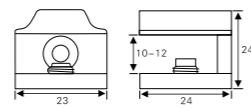

- 材质: 锌合金
Material: Zinc alloy
- 表面处理: 光络、拉丝镍、仿金、珍珠络、珍珠镍、红古铜、青古铜、枪黑
Finish: Chrome, Brush Nickel-Golden, Matt Chrome, Peel Nickel, Bronze, Green bronze, Lance Black
- 适用范围: 玻璃层板、木层板
Available For: Glass shelf and wooden plywood



CM 114-6

玻璃厚度: 4-6mm
Glass thickness: 4-6mm

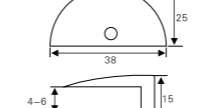

CM 114-8

玻璃厚度: 6-8mm
Glass thickness: 6-8mm

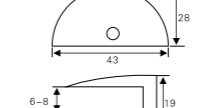

CM 114-10

玻璃厚度: 8-10mm
Glass thickness: 8-10mm

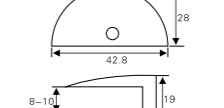

- 材质: 锌合金
Material: Zinc alloy
- 表面处理: 光络、拉丝镍、仿金、珍珠络、珍珠镍、红古铜、青古铜、枪黑
Finish: Chrome, Brush Nickel-Golden, Matt Chrome, Peel Nickel, Bronze, Green bronze, Lance Black
- 适用范围: 玻璃层板、木层板
Available For: Glass shelf and wooden plywood



CM 110-8

玻璃厚度: 6-8mm
Glass thickness: 6-8mm

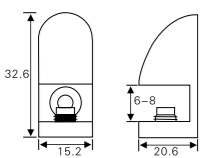

CM 110-10

玻璃厚度: 8-10mm
Glass thickness: 8-10mm

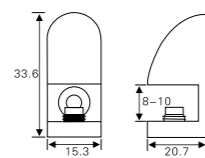

CM 111

玻璃厚度: 10-12mm
Glass thickness: 10-12mm

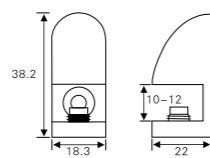

- 材质: 锌合金
Material: Zinc alloy
- 表面处理: 光络、拉丝镍、仿金、珍珠络、珍珠镍、红古铜、青古铜、枪黑
Finish: Chrome, Brush Nickel-Golden, Matt Chrome, Peel Nickel, Bronze, Green bronze, Lance Black
- 适用范围: 玻璃层板、木层板
Available For: Glass shelf and wooden plywood



CM 118

玻璃厚度: 10mm
Glass thickness: 10mm

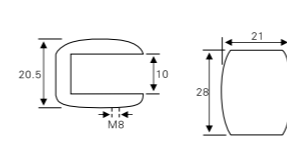

CM 119

玻璃厚度: 12mm
Glass thickness: 12mm

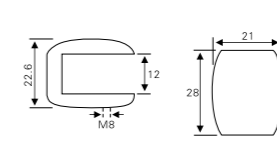

- 材质: 锌合金
Material: Zinc alloy
- 表面处理: 光络、拉丝镍、仿金、珍珠络、珍珠镍、红古铜、青古铜、枪黑
Finish: Chrome, Brush Nickel-Golden, Matt Chrome, Peel Nickel, Bronze, Green bronze, Lance Black
- 适用范围: 玻璃层板、木层板
Available For: Glass shelf and wooden plywood



CM 125

玻璃厚度: 8-10mm
Glass thickness: 8-10mm

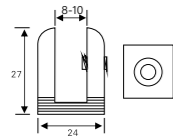

CM 120

玻璃厚度: 8mm
Glass thickness: 8mm

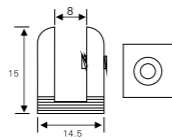

材质: 锌合金
Material: Zinc alloy

表面处理: 光络、拉丝镍、仿金、珍珠络、珍珠镍、红古铜、青古铜、枪黑
Finish: Chrome, Brush Nickel-Golden, Matt Chrome, Peal Nickel, Bronze, Green bronze, Lance Black

适用范围: 玻璃层板、木层板
Available For: Glass shelf and wooden plywood



CM 800

玻璃厚度: 8mm
Glass thickness: 8mm

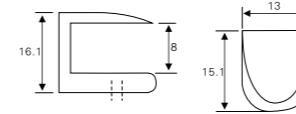

CM 801

玻璃厚度: 8mm
Glass thickness: 8mm

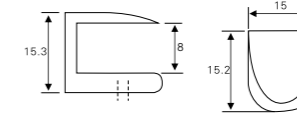

材质: 锌合金
Material: Zinc alloy

表面处理: 光络、拉丝镍、仿金、珍珠络、珍珠镍、红古铜、青古铜、枪黑
Finish: Chrome, Brush Nickel-Golden, Matt Chrome, Peal Nickel, Bronze, Green bronze, Lance Black

适用范围: 玻璃层板、木层板
Available For: Glass shelf and wooden plywood



CM 121-10

玻璃厚度: 10mm
Glass thickness: 10mm

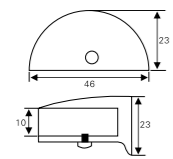

CM 121-12

玻璃厚度: 12mm
Glass thickness: 12mm

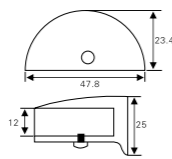

材质: 锌合金
Material: Zinc alloy

表面处理: 光络、拉丝镍、仿金、珍珠络、珍珠镍、红古铜、青古铜、枪黑
Finish: Chrome, Brush Nickel-Golden, Matt Chrome, Peal Nickel, Bronze, Green bronze, Lance Black

适用范围: 玻璃层板、木层板
Available For: Glass shelf and wooden plywood



CM 189

玻璃厚度: 8mm
Glass thickness: 8mm

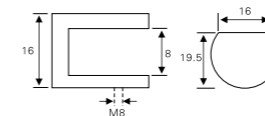

CM 126

玻璃厚度: 12mm
Glass thickness: 12mm

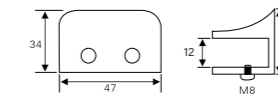

材质: 锌合金
Material: Zinc alloy

表面处理: 光络、拉丝镍、仿金、珍珠络、珍珠镍、红古铜、青古铜、枪黑
Finish: Chrome, Brush Nickel-Golden, Matt Chrome, Peal Nickel, Bronze, Green bronze, Lance Black

适用范围: 玻璃层板、木层板
Available For: Glass shelf and wooden plywood



CM 123

玻璃厚度: 6mm
Glass thickness: 6mm

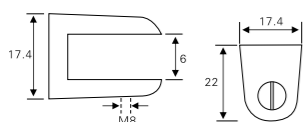

CM 124

玻璃厚度: 8mm
Glass thickness: 8mm

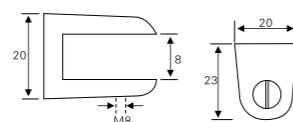

材质: 锌合金
Material: Zinc alloy

表面处理: 光络、拉丝镍、仿金、珍珠络、珍珠镍、红古铜、青古铜、枪黑
Finish: Chrome, Brush Nickel-Golden, Matt Chrome, Peal Nickel, Bronze, Green bronze, Lance Black

适用范围: 玻璃层板、木层板
Available For: Glass shelf and wooden plywood



CM 127-10

玻璃厚度: 10mm
Glass thickness: 10mm

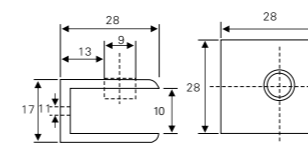

CM 127-12

玻璃厚度: 12mm
Glass thickness: 12mm

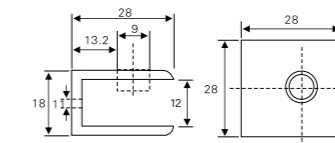

材质: 锌合金
Material: Zinc alloy

表面处理: 光络、拉丝镍、仿金、珍珠络、珍珠镍、红古铜、青古铜、枪黑
Finish: Chrome, Brush Nickel-Golden, Matt Chrome, Peal Nickel, Bronze, Green bronze, Lance Black

适用范围: 玻璃层板、木层板
Available For: Glass shelf and wooden plywood



CM 128-10

玻璃厚度: 10mm
Glass thickness: 10mm

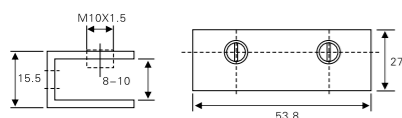

CM 128-12

玻璃厚度: 12mm
Glass thickness: 12mm

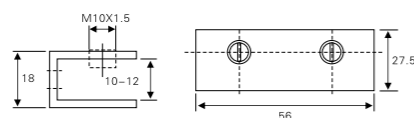

- 材质: 锌合金
Material: Zinc alloy
- 表面处理: 光络、拉丝镍、仿金、珍珠络、珍珠镍、红古铜、青古铜、枪黑
Finish: Chrome, Brush Nickel-Golden, Matt Chrome, Peal Nickel, Bronze, Green bronze, Lance Black
- 适用范围: 玻璃层板、木层板
Available For: Glass shelf and wooden plywood



CM 136-8

玻璃厚度: 6-8mm
Glass thickness: 6-8mm

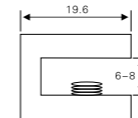

CM 136-10

玻璃厚度: 8-10mm
Glass thickness: 8-10mm

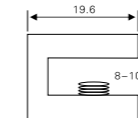

CM 136-12

玻璃厚度: 10-12mm
Glass thickness: 10-12mm

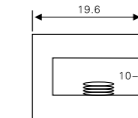

- 材质: 锌合金
Material: Zinc alloy
- 表面处理: 光络、拉丝镍、仿金、珍珠络、珍珠镍、红古铜、青古铜、枪黑
Finish: Chrome, Brush Nickel-Golden, Matt Chrome, Peal Nickel, Bronze, Green bronze, Lance Black
- 适用范围: 玻璃层板、木层板
Available For: Glass shelf and wooden plywood



CM 130

玻璃厚度: 10mm
Glass thickness: 10mm

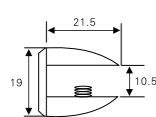

CM 131

玻璃厚度: 10mm
Glass thickness: 10mm

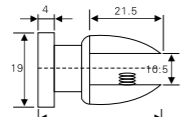

CM 132

玻璃厚度: 10mm
Glass thickness: 10mm

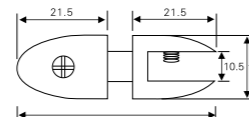

- 材质: 锌合金
Material: Zinc alloy
- 表面处理: 光络、拉丝镍、仿金、珍珠络、珍珠镍、红古铜、青古铜、枪黑
Finish: Chrome, Brush Nickel-Golden, Matt Chrome, Peal Nickel, Bronze, Green bronze, Lance Black
- 适用范围: 玻璃层板、木层板
Available For: Glass shelf and wooden plywood



CM 819

玻璃厚度: 6-8mm
Glass thickness: 6-8mm

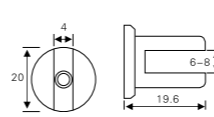

CM 820

玻璃厚度: 8-10mm
Glass thickness: 8-10mm

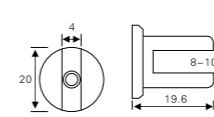

CM 821

玻璃厚度: 10-12mm
Glass thickness: 10-12mm

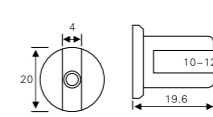

- 材质: 锌合金
Material: Zinc alloy
- 表面处理: 光络、拉丝镍、仿金、珍珠络、珍珠镍、红古铜、青古铜、枪黑
Finish: Chrome, Brush Nickel-Golden, Matt Chrome, Peal Nickel, Bronze, Green bronze, Lance Black
- 适用范围: 玻璃层板、木层板
Available For: Glass shelf and wooden plywood



CM 133

玻璃厚度: 8mm
Glass thickness: 8mm

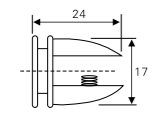

CM 134

玻璃厚度: 8mm
Glass thickness: 8mm

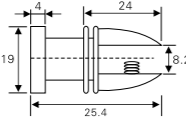

CM 135

玻璃厚度: 8mm
Glass thickness: 8mm

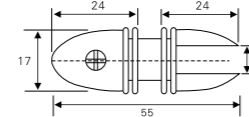

- 材质: 锌合金
Material: Zinc alloy
- 表面处理: 光络、拉丝镍、仿金、珍珠络、珍珠镍、红古铜、青古铜、枪黑
Finish: Chrome, Brush Nickel-Golden, Matt Chrome, Peal Nickel, Bronze, Green bronze, Lance Black
- 适用范围: 玻璃层板、木层板
Available For: Glass shelf and wooden plywood



CM 137-8

玻璃厚度: 6-8mm
Glass thickness: 6-8mm

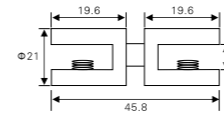

CM 137-10

玻璃厚度: 8-10mm
Glass thickness: 8-10mm

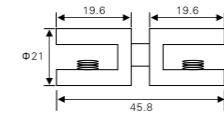

CM 137-12

玻璃厚度: 10-12mm
Glass thickness: 10-12mm

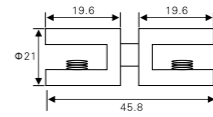

- 材质: 锌合金
Material: Zinc alloy
- 表面处理: 光络、拉丝镍、仿金、珍珠络、珍珠镍、红古铜、青古铜、枪黑
Finish: Chrome, Brush Nickel-Golden, Matt Chrome, Peal Nickel, Bronze, Green bronze, Lance Black
- 适用范围: 玻璃层板、木层板
Available For: Glass shelf and wooden plywood



CM 172

玻璃厚度: 8-10mm
Glass thickness: 8-10mm

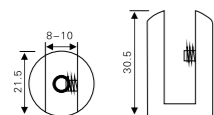

CM 173

玻璃厚度: 8-10mm
Glass thickness: 8-10mm

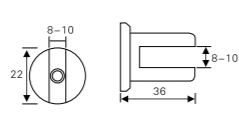

材质: 锌合金
Material: Zinc alloy

表面处理: 光络、拉丝镍、仿金、珍珠络、珍珠镍、红古铜、青古铜、枪黑
Finish: Chrome, Brush Nickel-Golden, Matt Chrome, Peal Nickel, Bronze, Green bronze, Lance Black

适用范围: 玻璃层板、木层板
Available For: Glass shelf and wooden plywood



CM 046

玻璃厚度: 6mm
Glass thickness: 6mm

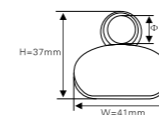

CM 042

玻璃厚度: 6mm
Glass thickness: 6mm

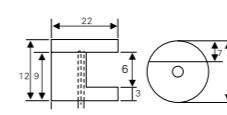

CM 044

玻璃厚度: 6mm
Glass thickness: 6mm

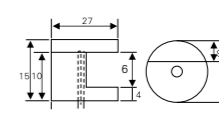

材质: 锌合金
Material: Zinc alloy

表面处理: 光络、拉丝镍、仿金、珍珠络、珍珠镍、红古铜、青古铜、枪黑
Finish: Chrome, Brush Nickel-Golden, Matt Chrome, Peal Nickel, Bronze, Green bronze, Lance Black

适用范围: 固定镜子
Available For: Fixed Mirror



CM 138

玻璃厚度: 8mm
Glass thickness: 8mm

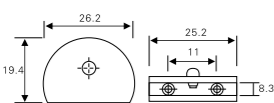

CM 139

玻璃厚度: 10mm
Glass thickness: 10mm

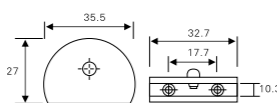

CM 140

玻璃厚度: 12mm
Glass thickness: 12mm

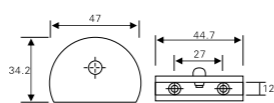

材质: 锌合金
Material: Zinc alloy

表面处理: 光络、拉丝镍、仿金、珍珠络、珍珠镍、红古铜、青古铜、枪黑
Finish: Chrome, Brush Nickel-Golden, Matt Chrome, Peal Nickel, Bronze, Green bronze, Lance Black

适用范围: 玻璃层板、木层板
Available For: Glass shelf and wooden plywood



CM 044A

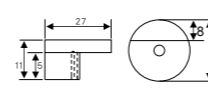

CM 043



CM 045

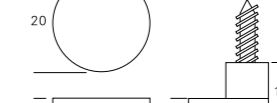

材质: 锌合金
Material: Zinc alloy

表面处理: 光络、拉丝镍、仿金、珍珠络、珍珠镍、红古铜、青古铜、枪黑
Finish: Chrome, Brush Nickel-Golden, Matt Chrome, Peal Nickel, Bronze, Green bronze, Lance Black

适用范围: 固定镜子
Available For: Fixed Mirror



CM 141

玻璃厚度: 8mm
Glass thickness: 8mm

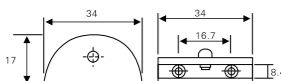

CM 142

玻璃厚度: 10mm
Glass thickness: 10mm

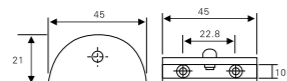

CM 143

玻璃厚度: 12mm
Glass thickness: 12mm

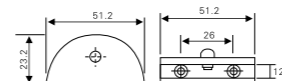

材质: 锌合金
Material: Zinc alloy

表面处理: 光络、拉丝镍、仿金、珍珠络、珍珠镍、红古铜、青古铜、枪黑
Finish: Chrome, Brush Nickel-Golden, Matt Chrome, Peal Nickel, Bronze, Green bronze, Lance Black

适用范围: 玻璃层板、木层板
Available For: Glass shelf and wooden plywood



CM 050

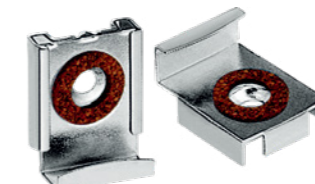
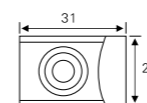

CM 051

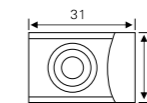

材质: 铁
Material: Iron

表面处理: 光络、沙镍
Finish: Chrome, Matt Nickel

适用范围: 固定镜子
Available For: Fixed Mirror



CM 534

玻璃厚度: 8mm
Glass thickness: 8mm

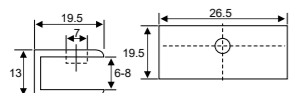

CM 535

玻璃厚度: 10mm
Glass thickness: 10mm

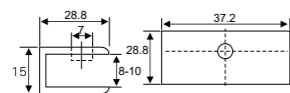

CM 536

玻璃厚度: 12mm
Glass thickness: 12mm

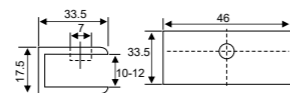

材质: 不锈钢
Material: Stainless steel

表面处理: 拉丝、亮光
Finish: Satin, Polish

适用范围: 玻璃层板、木层板
Available For: Glass shelf and wooden plywood



CM 822

玻璃厚度: 6-8mm
Glass thickness: 6-8mm

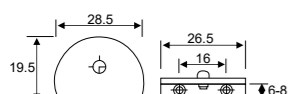

CM 823

玻璃厚度: 8-10mm
Glass thickness: 8-10mm

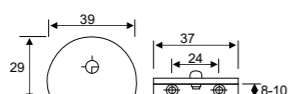

CM 824

玻璃厚度: 10-12mm
Glass thickness: 10-12mm

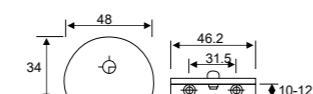

材质: 不锈钢
Material: Stainless steel

表面处理: 拉丝、亮光
Finish: Satin, Polish

适用范围: 玻璃层板、木层板
Available For: Glass shelf and wooden plywood



CM 804

玻璃厚度: 10mm/12mm
Glass thickness: 10mm/12mm

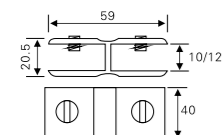

CM 805

玻璃厚度: 10mm/12mm
Glass thickness: 10mm/12mm

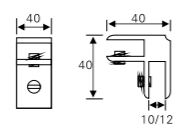

材质: 太空铝
Material: Aluminum

表面处理: 哑光
Finish: Matt

适用范围: 玻璃层板、木层板
Available For: Glass shelf and wooden plywood



CM 806

玻璃厚度: 10mm/12mm
Glass thickness: 10mm/12mm

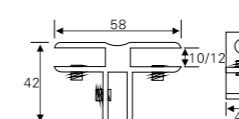

材质: 太空铝
Material: Aluminum

表面处理: 哑光
Finish: Matt

适用范围: 玻璃层板、木层板
Available For: Glass shelf and wooden plywood



CM 807

玻璃厚度: 10mm/12mm
Glass thickness: 10mm/12mm

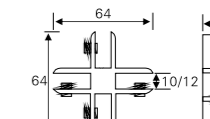

CM 817

玻璃厚度: 8mm/10mm/12mm
Glass thickness: 8mm/10mm/12mm

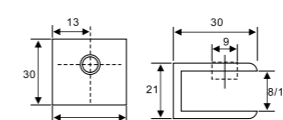

材质: 太空铝
Material: Aluminum

表面处理: 哑光
Finish: Matt

适用范围: 玻璃层板、木层板
Available For: Glass shelf and wooden plywood



CM 818

玻璃厚度: 8mm/10mm/12mm
Glass thickness: 8mm/10mm/12mm

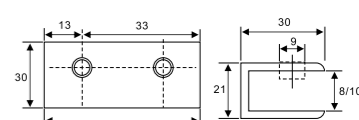

CM 986

玻璃厚度: 10-12mm
Glass thickness: 10-12mm

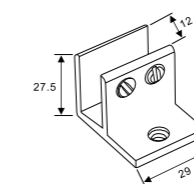

材质: 太空铝
Material: Aluminum

表面处理: 哑光
Finish: Matt

适用范围: 玻璃层板、木层板
Available For: Glass shelf and wooden plywood



CM 987

玻璃厚度: 10-12mm
Glass thickness: 10-12mm

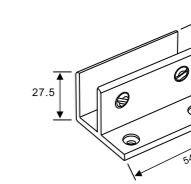

CM 988

玻璃厚度: 10-12mm
Glass thickness: 10-12mm

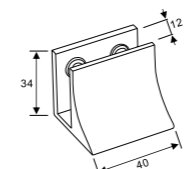

材质: 太空铝
Material: Aluminum

表面处理: 哑光
Finish: Matt

适用范围: 玻璃层板、木层板
Available For: Glass shelf and wooden plywood



CM 989

玻璃厚度: 6-8mm
Glass thickness: 6-8mm

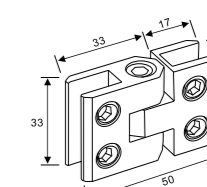



Φ16

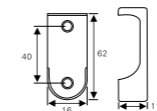

CM 183

材质: 锌合金
Material: Zinc alloy
表面处理: 光络、拉丝镍、仿金、珍珠络、珍珠镍、红古铜、青古铜、枪黑
Finish: Chrome, Brush Nickel, Golden, Matt Chrome, Peal Nickel, Bronze, Green bronze, Lance Black



Φ16、Φ19、Φ25

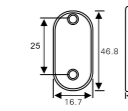

CM 184-2

材质: 锌合金
Material: Zinc alloy
表面处理: 光络、拉丝镍、仿金、珍珠络、珍珠镍、红古铜、青古铜、枪黑
Finish: Chrome, Brush Nickel, Golden, Matt Chrome, Peal Nickel, Bronze, Green bronze, Lance Black



Φ16

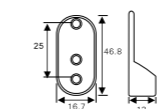

CM 184-3

材质: 锌合金
Material: Zinc alloy
表面处理: 光络、拉丝镍、仿金、珍珠络、珍珠镍、红古铜、青古铜、枪黑
Finish: Chrome, Brush Nickel, Golden, Matt Chrome, Peal Nickel, Bronze, Green bronze, Lance Black



Φ16

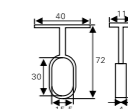

CM 185

材质: 锌合金
Material: Zinc alloy
表面处理: 光络、拉丝镍、仿金、珍珠络、珍珠镍、红古铜、青古铜、枪黑
Finish: Chrome, Brush Nickel, Golden, Matt Chrome, Peal Nickel, Bronze, Green bronze, Lance Black



Φ16

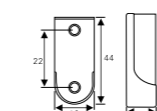

CM 900

材质: 锌合金
Material: Zinc alloy
表面处理: 光络、拉丝镍、仿金、珍珠络、珍珠镍、红古铜、青古铜、枪黑
Finish: Chrome, Brush Nickel, Golden, Matt Chrome, Peal Nickel, Bronze, Green bronze, Lance Black



Φ16

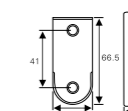

CM 901

材质: 锌合金
Material: Zinc alloy
表面处理: 光络、拉丝镍、仿金、珍珠络、珍珠镍、红古铜、青古铜、枪黑
Finish: Chrome, Brush Nickel, Golden, Matt Chrome, Peal Nickel, Bronze, Green bronze, Lance Black



Φ19

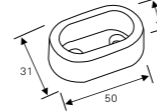

CM 902

材质: 锌合金
Material: Zinc alloy
表面处理: 光络、拉丝镍、仿金、珍珠络、珍珠镍、红古铜、青古铜、枪黑
Finish: Chrome, Brush Nickel, Golden, Matt Chrome, Peal Nickel, Bronze, Green bronze, Lance Black



Φ19/Φ25

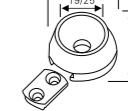

CM 903

材质: 锌合金
Material: Zinc alloy
表面处理: 光络、拉丝镍、仿金、珍珠络、珍珠镍、红古铜、青古铜、枪黑
Finish: Chrome, Brush Nickel, Golden, Matt Chrome, Peal Nickel, Bronze, Green bronze, Lance Black



Φ16

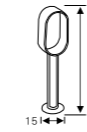

CM 904

材质: 锌合金
Material: Zinc alloy
表面处理: 光络、拉丝镍、仿金、珍珠络、珍珠镍、红古铜、青古铜、枪黑
Finish: Chrome, Brush Nickel, Golden, Matt Chrome, Peal Nickel, Bronze, Green bronze, Lance Black



Φ16

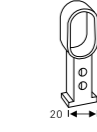

CM 905

材质: 锌合金
Material: Zinc alloy
表面处理: 光络、拉丝镍、仿金、珍珠络、珍珠镍、红古铜、青古铜、枪黑
Finish: Chrome, Brush Nickel, Golden, Matt Chrome, Peal Nickel, Bronze, Green bronze, Lance Black

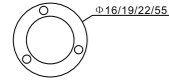

CM 906

- 材质: 锌合金
Material: Zinc alloy
- 表面处理: 光络、拉丝镍、仿金、珍珠络、珍珠镍、红古铜、青古铜、枪黑
Finish: Chrome, Brush Nickel, Golden, Matt Chrome, Peal Nickel, Bronze, Green bronze, Lance Black

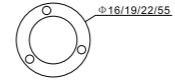

CM 907

- 材质: 锌合金
Material: Zinc alloy
- 表面处理: 光络、拉丝镍、仿金、珍珠络、珍珠镍、红古铜、青古铜、枪黑
Finish: Chrome, Brush Nickel, Golden, Matt Chrome, Peal Nickel, Bronze, Green bronze, Lance Black

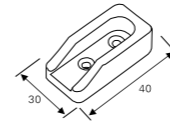

CM 935

- 材质: 锌合金
Material: Zinc alloy
- 表面处理: 光络、拉丝镍、仿金、珍珠络、珍珠镍、红古铜、青古铜、枪黑
Finish: Chrome, Brush Nickel, Golden, Matt Chrome, Peal Nickel, Bronze, Green bronze, Lance Black



CM 936

- 材质: 锌合金
Material: Zinc alloy
- 表面处理: 光络、拉丝镍、仿金、珍珠络、珍珠镍、红古铜、青古铜、枪黑
Finish: Chrome, Brush Nickel, Golden, Matt Chrome, Peal Nickel, Bronze, Green bronze, Lance Black

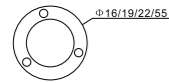

CM 973

- 材质: 锌合金
Material: Zinc alloy
- 表面处理: 光络、拉丝镍、仿金、珍珠络、珍珠镍、红古铜、青古铜、枪黑
Finish: Chrome, Brush Nickel, Golden, Matt Chrome, Peal Nickel, Bronze, Green bronze, Lance Black



CM 909

- 材质: 锌合金
Material: Zinc alloy
- 表面处理: 光络、拉丝镍、仿金、珍珠络、珍珠镍、红古铜、青古铜、枪黑
Finish: Chrome, Brush Nickel, Golden, Matt Chrome, Peal Nickel, Bronze, Green bronze, Lance Black



Φ16

CM 937

- 材质: 锌合金
Material: Zinc alloy
- 表面处理: 光络、拉丝镍、仿金、珍珠络、珍珠镍、红古铜、青古铜、枪黑
Finish: Chrome, Brush Nickel, Golden, Matt Chrome, Peal Nickel, Bronze, Green bronze, Lance Black



Φ19

CM 938

- 材质: 锌合金
Material: Zinc alloy
- 表面处理: 光络、拉丝镍、仿金、珍珠络、珍珠镍、红古铜、青古铜、枪黑
Finish: Chrome, Brush Nickel, Golden, Matt Chrome, Peal Nickel, Bronze, Green bronze, Lance Black

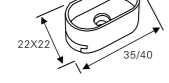

CM 931

Φ16/Φ19

- 材质: 锌合金
Material: Zinc alloy
- 表面处理: 光络、拉丝镍、仿金、珍珠络、珍珠镍、红古铜、青古铜、枪黑
Finish: Chrome, Brush Nickel, Golden, Matt Chrome, Peal Nickel, Bronze, Green bronze, Lance Black

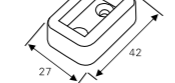

CM 932

Φ15

- 材质: 锌合金
Material: Zinc alloy
- 表面处理: 光络、拉丝镍、仿金、珍珠络、珍珠镍、红古铜、青古铜、枪黑
Finish: Chrome, Brush Nickel, Golden, Matt Chrome, Peal Nickel, Bronze, Green bronze, Lance Black



Φ25

CM 939

- 材质: 锌合金
Material: Zinc alloy
- 表面处理: 光络、拉丝镍、仿金、珍珠络、珍珠镍、红古铜、青古铜、枪黑
Finish: Chrome, Brush Nickel, Golden, Matt Chrome, Peal Nickel, Bronze, Green bronze, Lance Black



CM 940

- 材质: 锌合金
Material: Zinc alloy
- 表面处理: 光络、拉丝镍、仿金、珍珠络、珍珠镍、红古铜、青古铜、枪黑
Finish: Chrome, Brush Nickel, Golden, Matt Chrome, Peal Nickel, Bronze, Green bronze, Lance Black

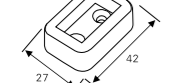

CM 974

- 材质: 锌合金
Material: Zinc alloy
- 表面处理: 光络、拉丝镍、仿金、珍珠络、珍珠镍、红古铜、青古铜、枪黑
Finish: Chrome, Brush Nickel, Golden, Matt Chrome, Peal Nickel, Bronze, Green bronze, Lance Black



CM 975

- 材质: 锌合金
Material: Zinc alloy
- 表面处理: 光络、拉丝镍、仿金、珍珠络、珍珠镍、红古铜、青古铜、枪黑
Finish: Chrome, Brush Nickel, Golden, Matt Chrome, Peal Nickel, Bronze, Green bronze, Lance Black



CM 941

- 材质: 锌合金
Material: Zinc alloy
- 表面处理: 光络、拉丝镍、仿金、珍珠络、珍珠镍、红古铜、青古铜、枪黑
Finish: Chrome, Brush Nickel, Golden, Matt Chrome, Peal Nickel, Bronze, Green bronze, Lance Black



Φ19

CM 942

- 材质: 锌合金
Material: Zinc alloy
- 表面处理: 光络、拉丝镍、仿金、珍珠络、珍珠镍、红古铜、青古铜、枪黑
Finish: Chrome, Brush Nickel, Golden, Matt Chrome, Peal Nickel, Bronze, Green bronze, Lance Black

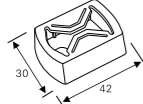

CM 933

- 材质: 锌合金
Material: Zinc alloy
- 表面处理: 光络、拉丝镍、仿金、珍珠络、珍珠镍、红古铜、青古铜、枪黑
Finish: Chrome, Brush Nickel, Golden, Matt Chrome, Peal Nickel, Bronze, Green bronze, Lance Black

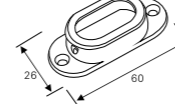

CM 934

Φ16

- 材质: 锌合金
Material: Zinc alloy
- 表面处理: 光络、拉丝镍、仿金、珍珠络、珍珠镍、红古铜、青古铜、枪黑
Finish: Chrome, Brush Nickel, Golden, Matt Chrome, Peal Nickel, Bronze, Green bronze, Lance Black



Φ25

CM 943 可调

- 材质: 锌合金
Material: Zinc alloy
- 表面处理: 光络、拉丝镍、仿金、珍珠络、珍珠镍、红古铜、青古铜、枪黑
Finish: Chrome, Brush Nickel, Golden, Matt Chrome, Peal Nickel, Bronze, Green bronze, Lance Black



Φ25

CM 944 可调

- 材质: 锌合金
Material: Zinc alloy
- 表面处理: 光络、拉丝镍、仿金、珍珠络、珍珠镍、红古铜、青古铜、枪黑
Finish: Chrome, Brush Nickel, Golden, Matt Chrome, Peal Nickel, Bronze, Green bronze, Lance Black



- 材质: 锌合金
Material: Zinc alloy
- 表面处理: 光络、拉丝镍、仿金、珍珠络、珍珠镍、红古铜、青古铜、枪黑
Finish: Chrome, Brush Nickel, Golden, Matt Chrome, Peal Nickel, Bronze, Green bronze, Lance Black

Φ16

CM 962 可调



- 材质: 锌合金
Material: Zinc alloy
- 表面处理: 光络、拉丝镍、仿金、珍珠络、珍珠镍、红古铜、青古铜、枪黑
Finish: Chrome, Brush Nickel, Golden, Matt Chrome, Peal Nickel, Bronze, Green bronze, Lance Black

Φ16

CM 963 可调



- 材质: 锌合金
Material: Zinc alloy
- 表面处理: 光络、拉丝镍、仿金、珍珠络、珍珠镍、红古铜、青古铜、枪黑
Finish: Chrome, Brush Nickel, Golden, Matt Chrome, Peal Nickel, Bronze, Green bronze, Lance Black

Φ16

CM 971



- 材质: 不锈钢
Material: Stainless steel
- 表面处理: 拉丝、光面
Finish: Satin, Polish

Φ38 Φ51

CM 949



- 材质: 锌合金
Material: Zinc alloy
- 表面处理: 光络、拉丝镍、仿金、珍珠络、珍珠镍、红古铜、青古铜、枪黑
Finish: Chrome, Brush Nickel, Golden, Matt Chrome, Peal Nickel, Bronze, Green bronze, Lance Black

Φ16

CM 964



- 材质: 锌合金
Material: Zinc alloy
- 表面处理: 光络、拉丝镍、仿金、珍珠络、珍珠镍、红古铜、青古铜、枪黑
Finish: Chrome, Brush Nickel, Golden, Matt Chrome, Peal Nickel, Bronze, Green bronze, Lance Black

Φ16

CM 965



- 材质: 不锈钢
Material: Stainless steel
- 表面处理: 拉丝、光面
Finish: Satin, Polish

Φ19 Φ20 Φ25 Φ32

CM 950



- 材质: 不锈钢
Material: Stainless steel
- 表面处理: 拉丝、光面
Finish: Satin, Polish

Φ19 Φ22 Φ25 Φ32

CM 951



- 材质: 锌合金
Material: Zinc alloy
- 表面处理: 光络、拉丝镍、仿金、珍珠络、珍珠镍、红古铜、青古铜、枪黑
Finish: Chrome, Brush Nickel, Golden, Matt Chrome, Peal Nickel, Bronze, Green bronze, Lance Black

Φ19

CM 972



- 材质: 锌合金
Material: Zinc alloy
- 表面处理: 仿金、珍珠络、珍珠镍、红古铜、青古铜、枪黑
Finish: Golden, Matt Chrome, Peal Nickel, Bronze, Green bronze, Lance Black

CM 966



- 材质: 不锈钢
Material: Stainless steel
- 表面处理: 拉丝、光面
Finish: Satin, Polish

Φ19 Φ20 Φ25 Φ32

CM 952



- 材质: 不锈钢
Material: Stainless steel
- 表面处理: 拉丝、光面
Finish: Satin, Polish

Φ25 Φ32

CM 953

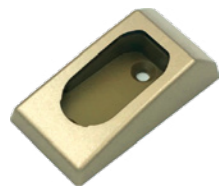

- 材质: 锌合金
Material: Zinc alloy
- 表面处理: 仿金、珍珠络、珍珠镍、红古铜、青古铜、枪黑
Finish: Golden, Matt Chrome, Peal Nickel, Bronze, Green bronze, Lance Black

Φ16

CM 967



- 材质: 锌合金
Material: Zinc alloy
- 表面处理: 光络、拉丝镍、仿金、珍珠络、珍珠镍、红古铜、青古铜、枪黑
Finish: Chrome, Brush Nickel, Golden, Matt Chrome, Peal Nickel, Bronze, Green bronze, Lance Black

CM 968



- 材质: 不锈钢
Material: Stainless steel
- 表面处理: 拉丝、光面
Finish: Satin, Polish

Φ25 Φ32

CM 954



- 材质: 不锈钢
Material: Stainless steel
- 表面处理: 拉丝、光面
Finish: Satin, Polish

Φ19 Φ22 Φ25

CM 955



- 材质: 锌合金
Material: Zinc alloy
- 表面处理: 光络、拉丝镍、仿金、珍珠络、珍珠镍、红古铜、青古铜、枪黑
Finish: Chrome, Brush Nickel, Golden, Matt Chrome, Peal Nickel, Bronze, Green bronze, Lance Black

Φ16

CM 969



- 材质: 锌合金
Material: Zinc alloy
- 表面处理: 光络、拉丝镍、仿金、珍珠络、珍珠镍、红古铜、青古铜、枪黑
Finish: Chrome, Brush Nickel, Golden, Matt Chrome, Peal Nickel, Bronze, Green bronze, Lance Black

Φ25

CM 970



- 材质: 不锈钢
Material: Stainless steel
- 表面处理: 拉丝、光面
Finish: Satin, Polish

Φ19 Φ22 Φ25

CM-Y018

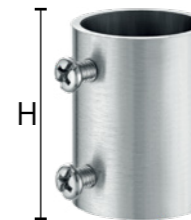

- 材质: 不锈钢
Material: Stainless steel
- 表面处理: 拉丝、光面
Finish: Satin, Polish

Φ25 Φ32
H: 40/60(mm)

CM-Y019



材质: 不锈钢
Material: Stainless steel
表面处理: 拉丝、光面
Finish: Satin, Polish

Φ25

CM-Y020



材质: 不锈钢
Material: Stainless steel
表面处理: 拉丝、光面
Finish: Satin, Polish

Φ16 Φ19 Φ22 Φ25 Φ32

CM-Y021

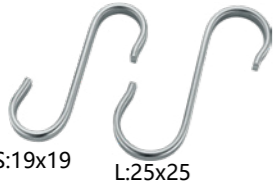

材质: 不锈钢
Material: Stainless steel
表面处理: 拉丝、光面
Finish: Satin, Polish

S:19x19 L:25x25

CM-Y022



材质: 不锈钢
Material: Stainless steel
表面处理: 拉丝、光面
Finish: Satin, Polish

Φ38 Φ51

CM-Y023

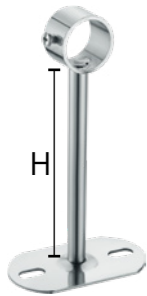

材质: 不锈钢
Material: Stainless steel
表面处理: 拉丝、光面
Finish: Satin, Polish

Φ25 Φ32
H:100/150/200/250/350/400(mm)

CM-Y024



材质: 不锈钢
Material: Stainless steel
表面处理: 拉丝、光面
Finish: Satin, Polish

Φ25 Φ32
H:100/150/200/250/350/400(mm)

CM-Y025



材质: 不锈钢
Material: Stainless steel
表面处理: 拉丝、光面
Finish: Satin, Polish

Φ25 Φ32
H:100/150/200/250/350/400(mm)

CM-Y026



材质: 不锈钢
Material: Stainless steel
表面处理: 拉丝、光面
Finish: Satin, Polish

Φ16 Φ19 Φ22 Φ25 Φ32

CM 957 空心圆头 Hollow



材质: 不锈钢
Material: Stainless steel
表面处理: 拉丝、光面
Finish: Satin, Polish

Φ19 Φ22 Φ25 Φ32

CM 961 空心圆通 Hollow



材质: 不锈钢
Material: Stainless steel
表面处理: 拉丝、光面
Finish: Satin, Polish

Φ19 Φ22 Φ25

CM 959 加长圆通



材质: 不锈钢
Material: Stainless steel
表面处理: 拉丝、光面
Finish: Satin, Polish

Φ19 Φ22 Φ25

CM 959A 加长圆通



材质: 不锈钢
Material: Stainless steel
表面处理: 拉丝、光面
Finish: Satin, Polish

Φ16 Φ19 Φ22 Φ25 Φ32

CM 958 实心圆头 Solid



材质: 不锈钢
Material: Stainless steel
表面处理: 拉丝、光面
Finish: Satin, Polish

Φ19 Φ22 Φ25 Φ32

CM 968 实心圆通 Solid

安装示例图

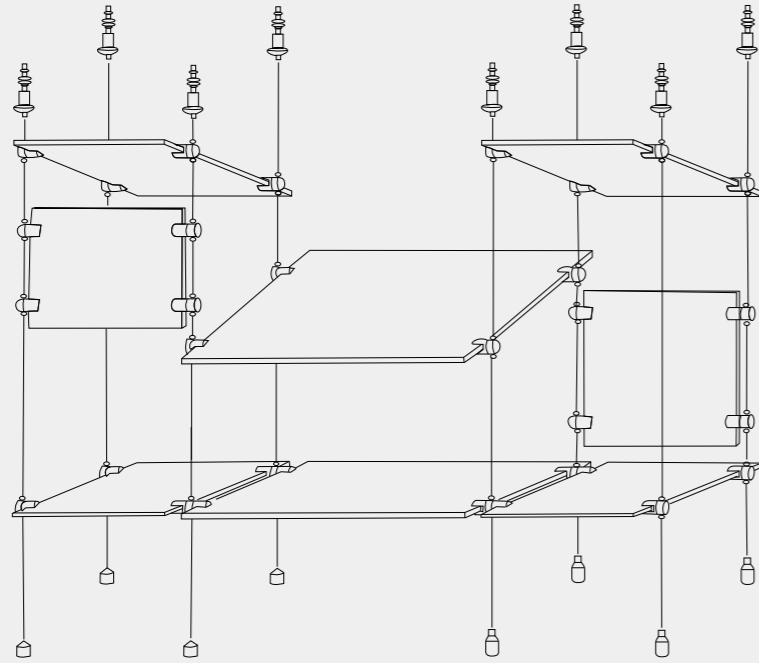

- 材质: 锌合金
Material: Zinc alloy
- 表面处理: 光络、拉丝镍、仿金、珍珠络、珍珠镍、红古铜、青古铜、枪黑
Finish: Chrome, Brush Nickel, Golden, Matt Chrome, Peal Nickel, Bronze, Green bronze, Lance Black

CM 910



- 材质: 锌合金
Material: Zinc alloy
- 表面处理: 光络、拉丝镍、仿金、珍珠络、珍珠镍、红古铜、青古铜、枪黑
Finish: Chrome, Brush Nickel, Golden, Matt Chrome, Peal Nickel, Bronze, Green bronze, Lance Black

CM 910-1



- 材质: 锌合金
Material: Zinc alloy
- 表面处理: 光络、拉丝镍、仿金、珍珠络、珍珠镍、红古铜、青古铜、枪黑
Finish: Chrome, Brush Nickel, Golden, Matt Chrome, Peal Nickel, Bronze, Green bronze, Lance Black

CM 911



- 材质: 锌合金
Material: Zinc alloy
- 表面处理: 光络、拉丝镍、仿金、珍珠络、珍珠镍、红古铜、青古铜、枪黑
Finish: Chrome, Brush Nickel, Golden, Matt Chrome, Peal Nickel, Bronze, Green bronze, Lance Black

CM 912



- 材质: 铁
Material: Iron
- 表面处理: 镀镍
Finish: Nickel

CM 913



- 材质: 锌合金
Material: Zinc alloy
- 表面处理: 光络、拉丝镍、仿金、珍珠络、珍珠镍、红古铜、青古铜、枪黑
Finish: Chrome, Brush Nickel, Golden, Matt Chrome, Peal Nickel, Bronze, Green bronze, Lance Black

CM 913-1



- 材质: 锌合金
Material: Zinc alloy
- 表面处理: 光络、拉丝镍、仿金、珍珠络、珍珠镍、红古铜、青古铜、枪黑
Finish: Chrome, Brush Nickel, Golden, Matt Chrome, Peal Nickel, Bronze, Green bronze, Lance Black

CM 914



- 材质: 锌合金
Material: Zinc alloy
- 表面处理: 光络、拉丝镍、仿金、珍珠络、珍珠镍、红古铜、青古铜、枪黑
Finish: Chrome, Brush Nickel, Golden, Matt Chrome, Peal Nickel, Bronze, Green bronze, Lance Black

CM 916



- 材质: 锌合金
Material: Zinc alloy
- 表面处理: 光络、拉丝镍、仿金、珍珠络、珍珠镍、红古铜、青古铜、枪黑
Finish: Chrome, Brush Nickel, Golden, Matt Chrome, Peal Nickel, Bronze, Green bronze, Lance Black

CM 918



- 材质: 锌合金
Material: Zinc alloy
- 表面处理: 光络、拉丝镍、仿金、珍珠络、珍珠镍、红古铜、青古铜、枪黑
Finish: Chrome, Brush Nickel, Golden, Matt Chrome, Peal Nickel, Bronze, Green bronze, Lance Black

CM 920



- 材质: 锌合金
Material: Zinc alloy
- 表面处理: 光络、拉丝镍、仿金、珍珠络、珍珠镍、红古铜、青古铜、枪黑
Finish: Chrome, Brush Nickel, Golden, Matt Chrome, Peal Nickel, Bronze, Green bronze, Lance Black

CM 921-1



- 材质: 锌合金
Material: Zinc alloy
- 表面处理: 光络、拉丝镍、仿金、珍珠络、珍珠镍、红古铜、青古铜、枪黑
Finish: Chrome, Brush Nickel, Golden, Matt Chrome, Peal Nickel, Bronze, Green bronze, Lance Black

CM 915



- 材质: 锌合金
Material: Zinc alloy
- 表面处理: 光络、拉丝镍、仿金、珍珠络、珍珠镍、红古铜、青古铜、枪黑
Finish: Chrome, Brush Nickel, Golden, Matt Chrome, Peal Nickel, Bronze, Green bronze, Lance Black

CM 917



- 材质: 锌合金
Material: Zinc alloy
- 表面处理: 光络、拉丝镍、仿金、珍珠络、珍珠镍、红古铜、青古铜、枪黑
Finish: Chrome, Brush Nickel, Golden, Matt Chrome, Peal Nickel, Bronze, Green bronze, Lance Black

CM 919



- 材质: 锌合金
Material: Zinc alloy
- 表面处理: 光络、拉丝镍、仿金、珍珠络、珍珠镍、红古铜、青古铜、枪黑
Finish: Chrome, Brush Nickel, Golden, Matt Chrome, Peal Nickel, Bronze, Green bronze, Lance Black

CM 921



- 材质: 锌合金
Material: Zinc alloy
- 表面处理: 光络、拉丝镍、仿金、珍珠络、珍珠镍、红古铜、青古铜、枪黑
Finish: Chrome, Brush Nickel, Golden, Matt Chrome, Peal Nickel, Bronze, Green bronze, Lance Black

CM 912



- 材质: 铁
Material: Iron
- 表面处理: 镀镍
Finish: Nickel

CM 923



- 材质: 锌合金
Material: Zinc alloy
- 表面处理: 光络、拉丝镍、仿金、珍珠络、珍珠镍、红古铜、青古铜、枪黑
Finish: Chrome, Brush Nickel, Golden, Matt Chrome, Peal Nickel, Bronze, Green bronze, Lance Black

CM 923-1

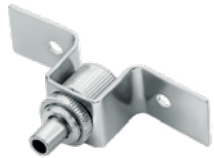

- 材质: 锌合金
Material: Zinc alloy
- 表面处理: 光络、拉丝镍、仿金、珍珠络、珍珠镍、红古铜、青古铜、枪黑
Finish: Chrome, Brush Nickel, Golden, Matt Chrome, Peal Nickel, Bronze, Green bronze, Lance Black

CM 924



- 材质: 锌合金
Material: Zinc alloy
- 表面处理: 光络、拉丝镍、仿金、珍珠络、珍珠镍、红古铜、青古铜、枪黑
Finish: Chrome, Brush Nickel, Golden, Matt Chrome, Peal Nickel, Bronze, Green bronze, Lance Black

CM 924-1



- 材质: 锌合金
Material: Zinc alloy
- 表面处理: 光络、拉丝镍、仿金、珍珠络、珍珠镍、红古铜、青古铜、枪黑
Finish: Chrome, Brush Nickel, Golden, Matt Chrome, Peal Nickel, Bronze, Green bronze, Lance Black

CM 925



- 材质: 锌合金
Material: Zinc alloy
- 表面处理: 光络、拉丝镍、仿金、珍珠络、珍珠镍、红古铜、青古铜、枪黑
Finish: Chrome, Brush Nickel, Golden, Matt Chrome, Peal Nickel, Bronze, Green bronze, Lance Black

CM 926



- 材质: 锌合金
Material: Zinc alloy
- 表面处理: 光络、拉丝镍、仿金、珍珠络、珍珠镍、红古铜、青古铜、枪黑
Finish: Chrome, Brush Nickel, Golden, Matt Chrome, Peal Nickel, Bronze, Green bronze, Lance Black

CM 927



- 材质: 锌合金
Material: Zinc alloy
- 表面处理: 光络、拉丝镍、仿金、珍珠络、珍珠镍、红古铜、青古铜、枪黑
Finish: Chrome, Brush Nickel, Golden, Matt Chrome, Peal Nickel, Bronze, Green bronze, Lance Black

CM 980



- 材质: 锌合金、铁
Material: Zinc alloy Iron
- 表面处理: 光络、拉丝镍、仿金、珍珠络、珍珠镍、红古铜、青古铜、枪黑
Finish: Chrome, Brush Nickel, Golden, Matt Chrome, Peal Nickel, Bronze, Green bronze, Lance Black

CM 981



个性化的立体组合, 造型美观时尚, 尽显出众风格; 表面光泽持久永恒, 演绎您的个性和品位, 让空间更怡然自得。

Personalized stereo combination, with beautiful and fashion appearance, shows its outstanding style. The everlasting gloss on the surface deduces your personality and taste, making the space become more satisfied.



CM 057



CM 058



CM 059



CM 060



CM 061



CM 062



CM 063



CM 064



CM 065



CM 066



CM 067



CM 068



CM 078

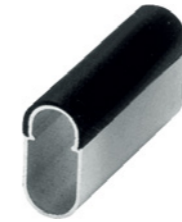

CM 079



CM 080



CM 069



CM 070



CM 071



CM 081



CM 082



CM 083



CM 072



CM 073



CM 074



CM 084



CM 085



CM 086



CM 087



CM 088



CM 089



CM 075



CM 076



CM 077



CM 090

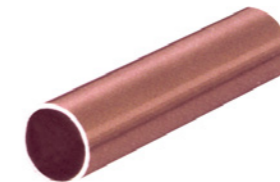

CM 091



CM 092

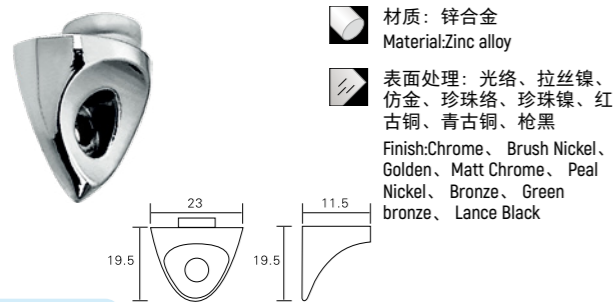

CM 193

- 材质: 锌合金
Material: Zinc alloy
- 表面处理: 光络、拉丝镍、仿金、珍珠络、珍珠镍、红古铜、青古铜、枪黑
Finish: Chrome, Brush Nickel, Golden, Matt Chrome, Peal Nickel, Bronze, Green bronze, Lance Black

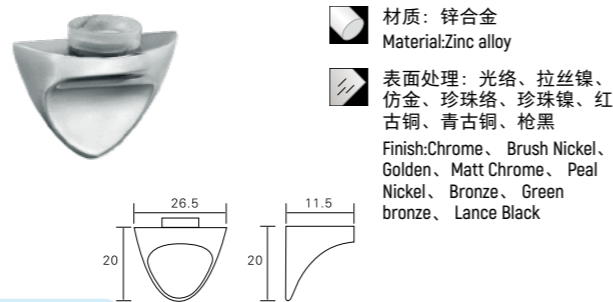

CM 194

- 材质: 锌合金
Material: Zinc alloy
- 表面处理: 光络、拉丝镍、仿金、珍珠络、珍珠镍、红古铜、青古铜、枪黑
Finish: Chrome, Brush Nickel, Golden, Matt Chrome, Peal Nickel, Bronze, Green bronze, Lance Black



CM 195

- 材质: 锌合金
Material: Zinc alloy
- 表面处理: 光络、拉丝镍、仿金、珍珠络、珍珠镍、红古铜、青古铜、枪黑
Finish: Chrome, Brush Nickel, Golden, Matt Chrome, Peal Nickel, Bronze, Green bronze, Lance Black

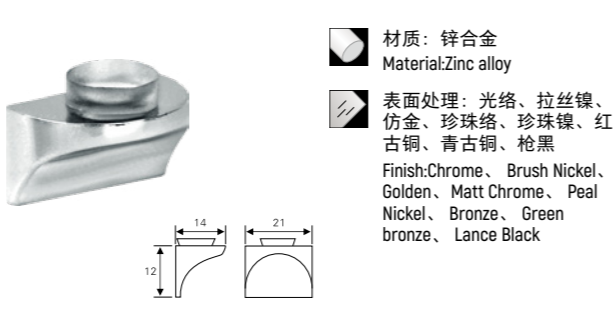

CM 196

- 材质: 锌合金
Material: Zinc alloy
- 表面处理: 光络、拉丝镍、仿金、珍珠络、珍珠镍、红古铜、青古铜、枪黑
Finish: Chrome, Brush Nickel, Golden, Matt Chrome, Peal Nickel, Bronze, Green bronze, Lance Black



CM 198

- 材质: 锌合金
Material: Zinc alloy
- 表面处理: 光络、拉丝镍、仿金、珍珠络、珍珠镍、红古铜、青古铜、枪黑
Finish: Chrome, Brush Nickel, Golden, Matt Chrome, Peal Nickel, Bronze, Green bronze, Lance Black

12.5g



CM 198A

- 材质: 锌合金
Material: Zinc alloy
- 表面处理: 光络、拉丝镍、仿金、珍珠络、珍珠镍、红古铜、青古铜、枪黑
Finish: Chrome, Brush Nickel, Golden, Matt Chrome, Peal Nickel, Bronze, Green bronze, Lance Black

8.8g

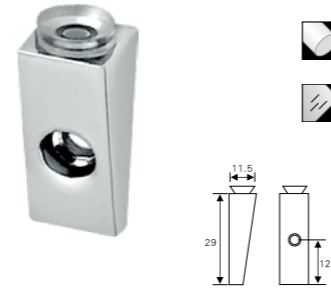

CM 202

- 材质: 锌合金
Material: Zinc alloy
- 表面处理: 光络、拉丝镍、仿金、珍珠络、珍珠镍、红古铜、青古铜、枪黑
Finish: Chrome, Brush Nickel, Golden, Matt Chrome, Peal Nickel, Bronze, Green bronze, Lance Black



CM 203 CM 203A

- 材质: 锌合金
Material: Zinc alloy
- 表面处理: 光络、拉丝镍、仿金、珍珠络、珍珠镍、红古铜、青古铜、枪黑
Finish: Chrome, Brush Nickel, Golden, Matt Chrome, Peal Nickel, Bronze, Green bronze, Lance Black

L: 5.3g

S: 4.0g

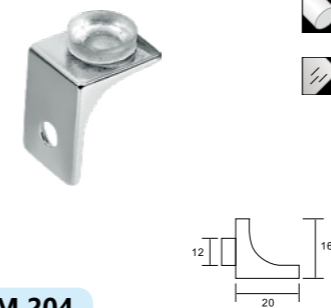

CM 204

- 材质: 锌合金
Material: Zinc alloy
- 表面处理: 光络、拉丝镍、仿金、珍珠络、珍珠镍、红古铜、青古铜、枪黑
Finish: Chrome, Brush Nickel, Golden, Matt Chrome, Peal Nickel, Bronze, Green bronze, Lance Black



CM 205

- 材质: 锌合金
Material: Zinc alloy
- 表面处理: 光络、拉丝镍、仿金、珍珠络、珍珠镍、红古铜、青古铜、枪黑
Finish: Chrome, Brush Nickel, Golden, Matt Chrome, Peal Nickel, Bronze, Green bronze, Lance Black

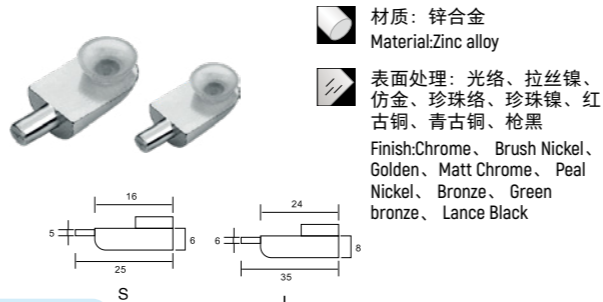

CM 206

- 材质: 锌合金
Material: Zinc alloy
- 表面处理: 光络、拉丝镍、仿金、珍珠络、珍珠镍、红古铜、青古铜、枪黑
Finish: Chrome, Brush Nickel, Golden, Matt Chrome, Peal Nickel, Bronze, Green bronze, Lance Black

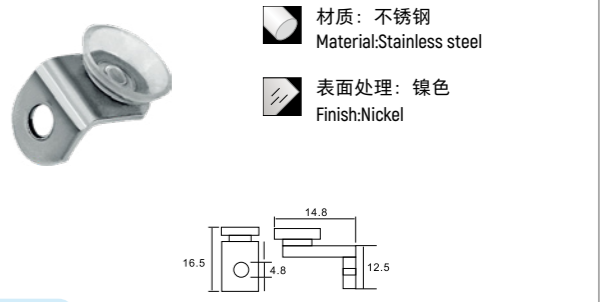

CM 503

- 材质: 不锈钢
Material: Stainless steel
- 表面处理: 镍色
Finish: Nickel



CM 505

- 材质: 不锈钢
Material: Stainless steel
- 表面处理: 镍色
Finish: Nickel

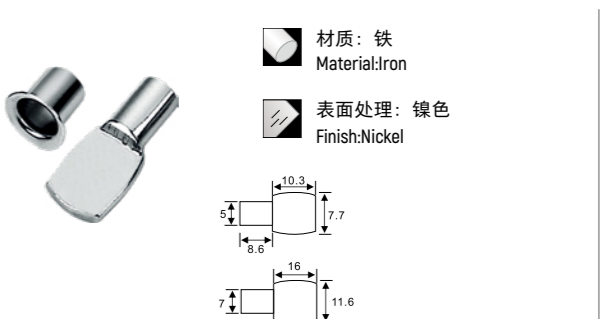

CM 209

- 材质: 铁
Material: Iron
- 表面处理: 镍色
Finish: Nickel



材质: 铁
Material: Iron
表面处理: 镀铬、镀镍
Finish: Chrome、Nickel

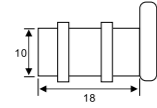

CM 212



材质: 铁
Material: Iron
表面处理: 镀铬、镀镍
Finish: Chrome、Nickel

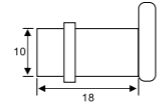

CM 213



材质: 铁
Material: Iron
表面处理: 镀铬、镀镍
Finish: Chrome、Nickel

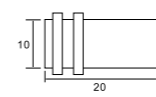

CM 224



材质: 铁
Material: Iron
表面处理: 镀铬、镀镍
Finish: Chrome、Nickel

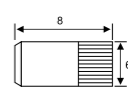

CM 225



材质: 锌合金
Material: Zinc alloy
表面处理: 镀铬、镀镍
Finish: Chrome、Nickel

CM 214



材质: 铁
Material: Iron
表面处理: 镀铬、镀镍
Finish: Chrome、Nickel

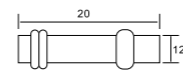

CM 220



材质: 铁
Material: Iron
表面处理: 镀铬、镀镍
Finish: Chrome、Nickel



CM 226



材质: 铁
Material: Iron
表面处理: 镀铬、镀镍
Finish: Chrome、Nickel

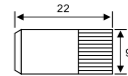

CM 228



材质: 铁
Material: Iron
表面处理: 镀铬、镀镍
Finish: Chrome、Nickel

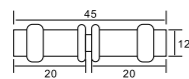

CM 211



材质: 锌合金
Material: Zinc alloy
表面处理: 镀镍
Finish: Nickel

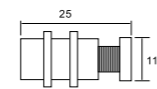

CM 216



材质: 铁
Material: Iron
表面处理: 镀铬、镀镍
Finish: Chrome、Nickel

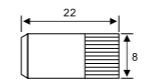

CM 227



材质: 铁
Material: Iron
表面处理: 镀铬、镀镍
Finish: Chrome、Nickel

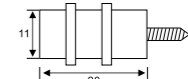

CM 229



材质: 锌合金
Material: Zinc alloy
表面处理: 镀镍
Finish: Nickel

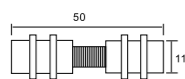

CM 217



材质: 铁
Material: Iron
表面处理: 镀铬、镀镍
Finish: Chrome、Nickel

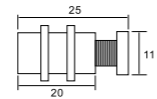

CM 219



材质: 铁
Material: Iron
表面处理: 镀铬、镀镍
Finish: Chrome、Nickel

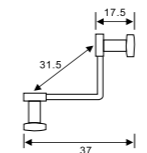

CM 233



材质: 铁
Material: Iron
表面处理: 镀铬、镀镍
Finish: Chrome、Nickel

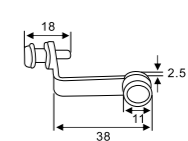

CM 234



材质: 铁
Material: Iron
表面处理: 镀铬、镀镍
Finish: Chrome、Nickel

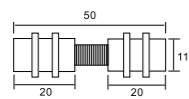

CM 218



材质: 铁
Material: Iron
表面处理: 镀铬、镀镍
Finish: Chrome、Nickel

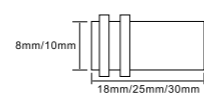

CM 223



材质: 铁
Material: Iron
表面处理: 镀铬、镀镍
Finish: Chrome、Nickel

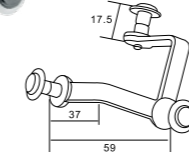

CM 235



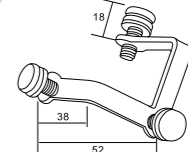

材质: 铁
Material: Iron
表面处理: 镀铬、镀镍
Finish: Chrome、Nickel

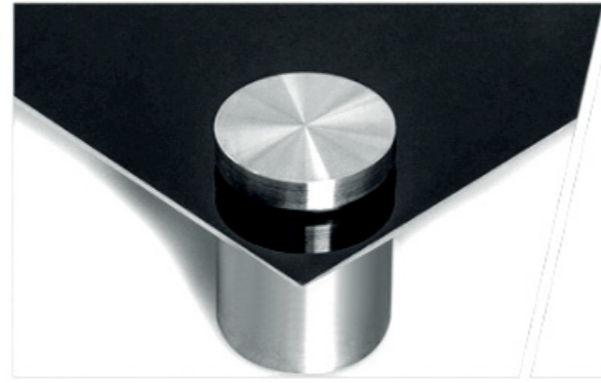

CM 236



-  材质: 实心不锈钢
Material: Solid Stainless steel
-  表面处理: 拉丝、亮光
Finish: Satin, Polish

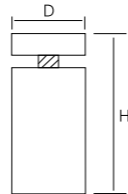

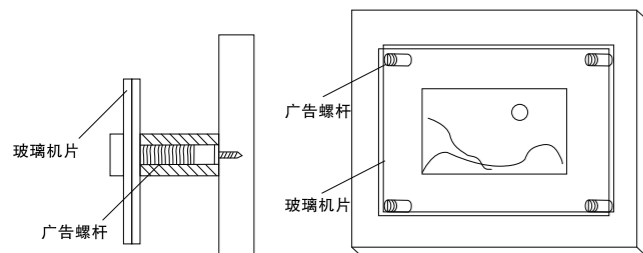

D	H	20	25	30	40	50	60	70	80	100
18	20	25	30	40	50	60	70	80	100	
25	20	25	30	40	50	60	70	80	100	
35	20	25	30	40	50	60	70	80	100	
40	20	25	30	40	50	60	70	80	100	

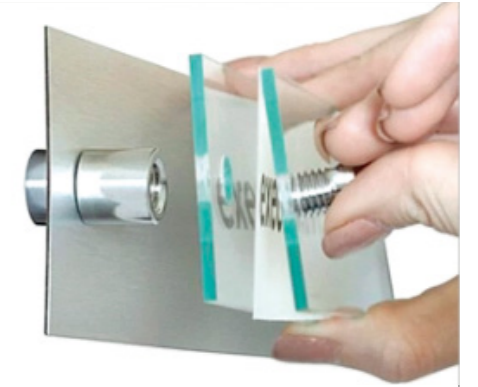

CM 257



-  材质: 空心不锈钢
Material: Hollow Stainless steel
-  表面处理: 拉丝、亮光
Finish: Satin, Polish

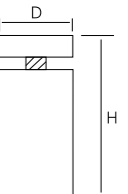

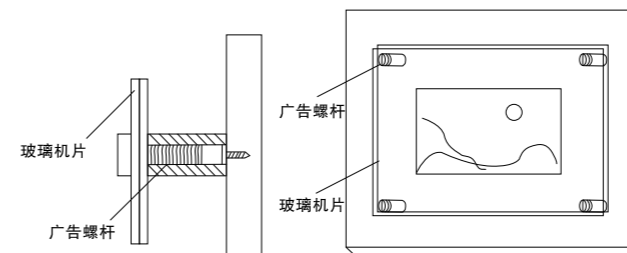

D	H	20	25	30	40	50	60	70	80	100
12	20	25	30	40	50	60	70	80	100	
16	20	25	30	40	50	60	70	80	100	
19	20	25	30	40	50	60	70	80	100	
25	20	25	30	40	50	60	70	80	100	
30	20	25	30	40	50	60	70	80	100	
40	20	25	30	40	50	60	70	80	100	



CM 258



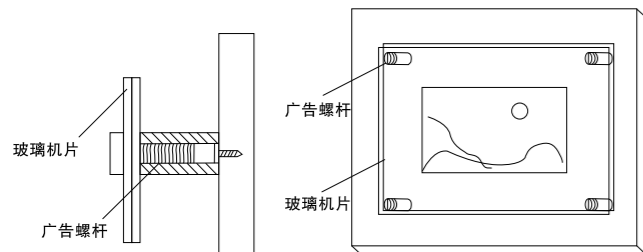
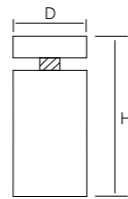

 材质: 空心不锈钢
Material: Hollow Stainless steel
 表面处理: 拉丝、亮光
Finish: Satin, Polish



D	H	20	25	30	40	50	60	70	80	100
12	20	25	30	40	50	60	70	80	100	
16	20	25	30	40	50	60	70	80	100	
19	20	25	30	40	50	60	70	80	100	
25	20	25	30	40	50	60	70	80	100	
30	20	25	30	40	50	60	70	80	100	
40	20	25	30	40	50	60	70	80	100	

CM 258-1



 材质: 不锈钢
Material: Stainless steel
 表面处理: 拉丝、亮光
Finish: White, Black, Red, Blue

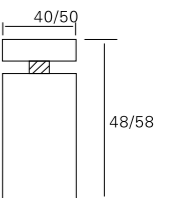

CM 985

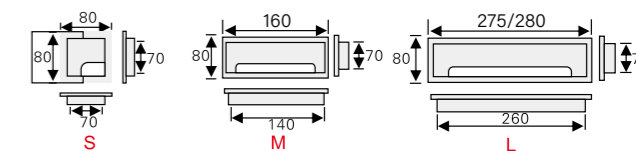

CM 372

注：规格及颜色可定做！
Size and color can be orderd
材质：铝合金
Material:Aluminium alloy
表面处理：哑光、黑色、白色
Material: Matt, black, white

产品尺寸：80x80/160/275/280mm
Product Size: 80x80/160/275/280mm
开孔尺寸：68x68/148/263/268mm
Hole Size: 68x68/148/263/268mm

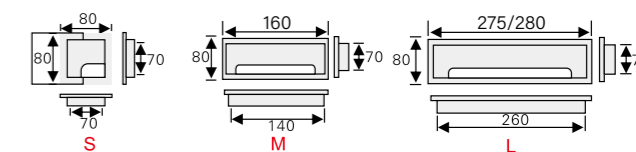

CM 372A

注：规格及颜色可定做！
Size and color can be orderd
材质：铝合金
Material:Aluminium alloy
表面处理：哑光、黑色、白色
Material: Matt, black, white

产品尺寸：80x80/160/275/280mm
Product Size: 80x80/160/275/280mm
开孔尺寸：68x68/148/263/268mm
Hole Size: 68x68/148/263/268mm

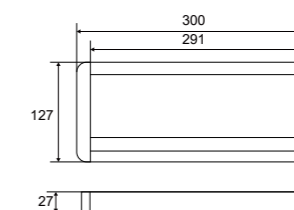

CM 378

注：规格及颜色可定做！
Size and color can be orderd

材质：铝合金
Material:Aluminium alloy
表面处理：哑光、黑色、白色
Material: Matt, black, white

产品尺寸：120x300mm
Product Size: 120x300mm
开孔尺寸：111x291mm
Hole Size: 111x291mm

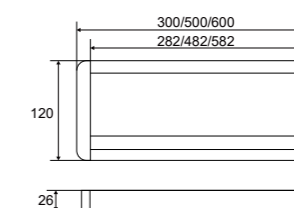

CM 375

注：规格及颜色可定做！
Size and color can be orderd

材质：铝合金
Material:Aluminium alloy
表面处理：哑光、黑色、白色
Material: Matt, black, white

产品尺寸：120x300/500/600mm
Product Size: 120x300/500/600mm
开孔尺寸：108x282/482/582mm
Hole Size: 108x282/482/582mm

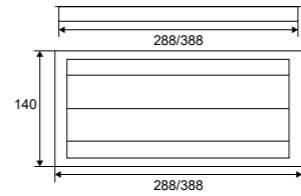

注：规格及颜色可定做！
Size and color can be orderd
材质：铝合金
Material:Aluminium alloy
表面处理：哑光、黑色、白色
Material: Matt, black, white
产品尺寸：140x300/400mm
Product Size: 140x300/400mm
开孔尺寸：128x288/388mm
Hole Size: 128x288/388mm

CM 376

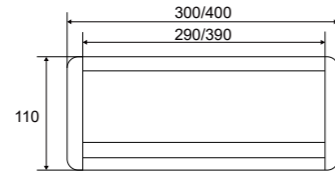

注：规格及颜色可定做！
Size and color can be orderd
材质：铝合金
Material:Aluminium alloy
表面处理：哑光、黑色、白色
Material: Matt, black, white
产品尺寸：110x300/400mm
Product Size: 110x300/400mm
开孔尺寸：110x290/390mm
Hole Size: 110x290/390mm

CM 374

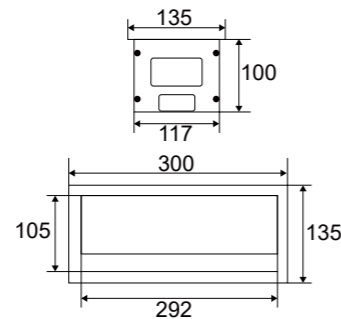

注：规格及颜色可定做！
Size and color can be orderd
材质：铝合金
Material:Aluminium alloy
表面处理：哑光、黑色、白色
Material: Matt, black, white
产品尺寸：135x300mm
Product Size: 135x300mm
开孔尺寸：119x292mm
Hole Size: 119x292mm

CM 377



材质：塑料
Material:Plastic
表面处理：白色
Material: white
产品尺寸：85x165mm
Product Size: 85x165mm
开孔尺寸：80x160mm
Hole Size: 80x160mm

CM-J009



材质：塑料
Material:Plastic
表面处理：白色
Material: white
产品尺寸：120x290mm
Product Size: 120x290mm
开孔尺寸：110x275mm
Hole Size: 110x275mm

CM-J010



材质：铝合金+ABS
Material:Aluminium alloy+ABS
表面处理：白色
Material: white
产品尺寸：376x260x125mm
Product Size: 376x260x125mm

CM-J011



材质：铝合金+ABS
Material:Aluminium alloy+ABS
表面处理：白色
Material: white
产品尺寸：340x147x125mm
Product Size: 340x147x125mm

CM-J012



CM-J001

材质: 铝合金
Material: Aluminium alloy
表面处理: 银色、黑色、白色
Material: Silver, black, white



CM-J002

材质: 铝合金
Material: Aluminium alloy
表面处理: 银色、黑色、白色
Material: Silver, black, white



CM-J003

材质: 铝合金
Material: Aluminium alloy
表面处理: 银色、黑色、白色
Material: Silver, black, white



CM-J003A

材质: 铝合金
Material: Aluminium alloy
表面处理: 银色、黑色、白色
Material: Silver, black, white

材质: 塑料、锌合金
Material: Plastic, Zinc alloy
表面处理: 光络、拉丝镍、仿金、珍珠络、珍珠镍、红古铜、青古铜、枪黑
Finish: Chrome, Brush Nickel-Golden, Matt Chrome, Peel Nickel, Bronze, Green bronze, Lance Black



43g

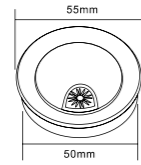

CM 360

材质: 塑料、锌合金
Material: Plastic, Zinc alloy
表面处理: 光络、拉丝镍、仿金、珍珠络、珍珠镍、红古铜、青古铜、枪黑
Finish: Chrome, Brush Nickel-Golden, Matt Chrome, Peel Nickel, Bronze, Green bronze, Lance Black



47g/55g/72g

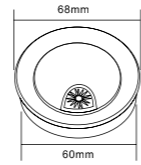

CM 361

材质: 塑料、锌合金
Material: Plastic, Zinc alloy
表面处理: 光络、拉丝镍、仿金、珍珠络、珍珠镍、红古铜、青古铜、枪黑
Finish: Chrome, Brush Nickel-Golden, Matt Chrome, Peel Nickel, Bronze, Green bronze, Lance Black



83g/104g/130g



CM 362

材质: 塑料、锌合金
Material: Plastic, Zinc alloy
表面处理: 光络、拉丝镍、仿金、珍珠络、珍珠镍、红古铜、青古铜、枪黑
Finish: Chrome, Brush Nickel-Golden, Matt Chrome, Peel Nickel, Bronze, Green bronze, Lance Black



CM 363

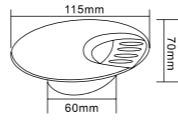

材质: 塑料、锌合金
Material: Plastic, Zinc alloy
表面处理: 光络、拉丝镍、仿金、珍珠络、珍珠镍、红古铜、青古铜、枪黑
Finish: Chrome, Brush Nickel-Golden, Matt Chrome, Peel Nickel, Bronze, Green bronze, Lance Black



CM 364

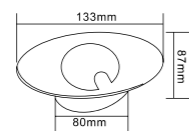

材质: 塑料、锌合金
Material: Plastic, Zinc alloy
表面处理: 光络、拉丝镍、仿金、珍珠络、珍珠镍、红古铜、青古铜、枪黑
Finish: Chrome, Brush Nickel-Golden, Matt Chrome, Peel Nickel, Bronze, Green bronze, Lance Black



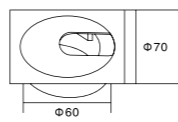

CM 365



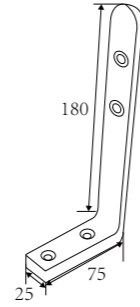

CM-J004



-  材质: 锌合金 + 铁
Material: Zinc alloy+Iron
-  表面处理: 黑色、白色
Material: black, white

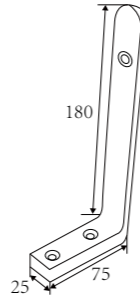

CM-J005



-  材质: 锌合金 + 铁
Material: Zinc alloy+Iron
-  表面处理: 黑色、白色
Material: black, white

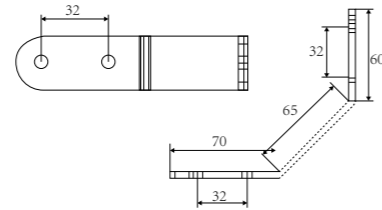

CM-J006

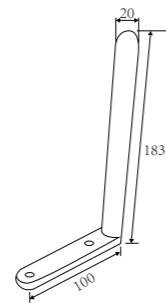

-  材质: 锌合金 + 铁
Material: Zinc alloy+Iron
-  表面处理: 黑色、白色
Material: black, white

CM-J007



-  材质: 铝合金
Material: Aluminium alloy
-  表面处理: 黑色、白色
Material: black, white

CM-J008

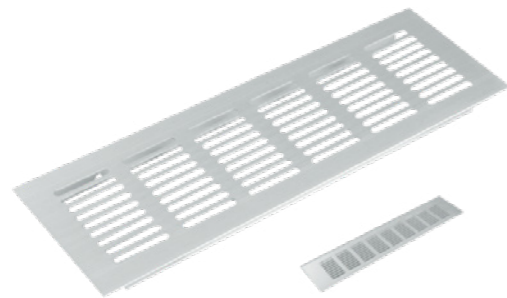

- 注: 规格可定做!
Size can be orderd
-  材质: 铝合金
Material: Aluminium alloy
 -  表面处理: 哑光
Material: Matt
- 产品尺寸: 80x300mm
Product Size: 80x300mm





CM 273



CM 273A



CM 274





CM 274A





CM 275



CM 275A

-  支撑力: 30N-150N
Force: 30N-150N
-  杆表面处理: 镀硬铬
Finish: Rigid chromium-plating





-  管表面处理: 镀铬、喷漆
Finish: Chromium-plating spray-paint
-  主要材质: 塑料、铁、铜
Main material: pom / iron / copper
-  包装数量: 100套 / 箱
Packing: 100pcs/CTN

- ★ Center: 245mm
- ★ Stroke: 90mm
- ★ Force: 30N -150N
- ★ Function: support, up, down, free stop, double step close
- ★ 中心距: 245mm
- ★ 行程: 90mm
- ★ 支撑力: 30N-150N
- ★ 可选功能: 上翻门支撑、下翻门缓冲、上翻门任意停、上翻门缓冲



产品特性
采用国际先进喷漆技术, 无毒环保。
有效防止腐蚀及生锈, 使用寿命达 50000 次。
宁静. 顺畅. 耐用

FEATURE
International advanced spray-paint technology.
nontoxic environment
Prevent the corrosion and rust effectively 50000
cycleSo.Tranquility, smooth.durability

可选择颜色 **Optional color**

- 12" 
- 10" 
- 8" 
- 6" 
- 12" 295mm
- 10" 245mm
- 8" 180mm
- 6" 158mm

可选择颜色 **Optional color**

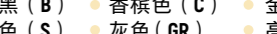
- B 
- C 
- GO 
- S 
- GR 
- W 
- 亚黑 (B)
- 香槟色 (C)
- 金色 (GO)
- 银色 (S)
- 灰色 (GR)
- 亮白 (W)

- ★ Usage: turn on the steam-driven support
- ★ Force Specifications: 30N-150N
- ★ Application: make the right turn on the weight of wooden | aluminum frame doors reveal a steady rate slowly upward.
- ★ 产品用途: 汽动上翻支撑
- ★ 举力规格: 30N-150N
- ★ 用途说明: 可使合适重量的上翻木门 / 铝框门稳定速度慢慢向上翻起。

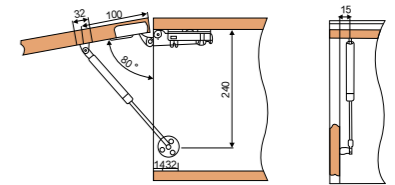

- ★ Uses: Hydraulic next turn support the
- ★ Application: can the next turn wooden | aluminum door frame slow steady downward turn.
- ★ 产品用途: 液压下翻支撑
- ★ 用途说明: 可使下翻木门 / 铝框门稳定速度缓慢向下翻。

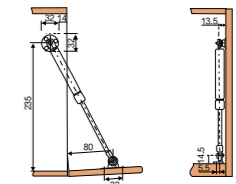

- ★ Usage: turn on the steam-driven support of any stop
- ★ Force Specifications: 50N-120N
- ★ Application: make the right turn on the weight of wooden | aluminum frame door 30° -90° between the opening angle of any intention to stay.
- ★ 产品用途: 汽动上翻任意停支撑
- ★ 举力规格: 50N-120N
- ★ 用途说明: 可使合适重量的上翻木门, 铝框门在 30° -90° 的开启角度之间任意停留。

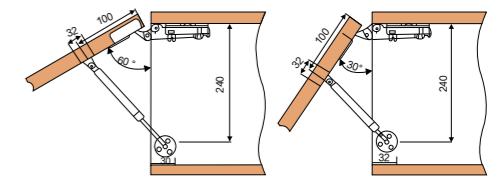

- ★ Uses: Hydraulic Flip Support
- ★ Force Specifications: 30N-150N
- ★ Application: make the right turn on the weight of wooden | aluminum frame door slowly tilting upward, and 60°-90° in the angle created between the opening buffer.
- ★ 产品用途: 液压上翻支撑
- ★ 举力规格: 30N-150N
- ★ 用途说明: 可使合适重量的上翻木门 / 铝框门慢慢向上翻起, 并能在 60° -90° 的开启角度之间产生缓冲作用。

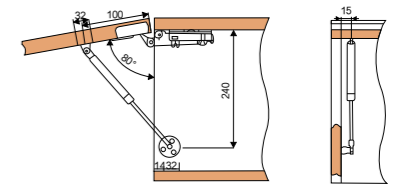

可选配件类型 **Optional accessories**

A3 (长孔铝门配件)

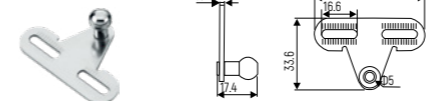

A5 (圆孔铝门配件)

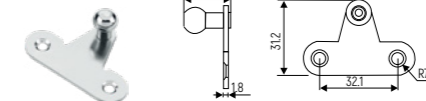

A4 (定位圆配件)

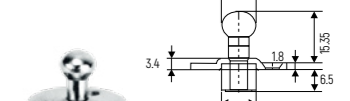

A6 (直角铝门配件)

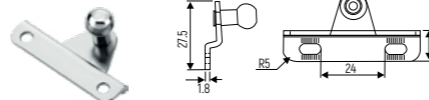

A5 (长孔直角配件)

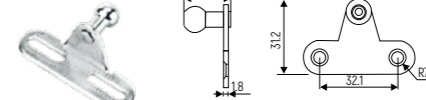



CM 276





CM 276A





CM 277



CM 277A

-  支撑力: 30N-150N
Force: 30N-150N
-  杆表面处理: 镀硬铬
Finish: Rigid chromium-plating





-  管表面处理: 镀铬、喷漆
Finish: Chromium-plating spray-paint
-  主要材质: 塑料、铁、铜
Main material: pom / iron / copper
-  包装数量: 100套 / 箱
Packing: 100pcs/CTN

- ★ Center: 245mm
- ★ Stroke: 90mm
- ★ Force: 30N -150N
- ★ Function: support, up, down, free stop, double step close
- ★ 中心距: 245mm
- ★ 行程: 90mm
- ★ 支撑力: 30N-150N
- ★ 可选功能: 上翻门支撑、下翻门缓冲、上翻门任意停、上翻门缓冲

产品特性
采用国际先进喷漆技术, 无毒环保。
有效防止腐蚀及生锈, 使用寿命达 50000 次。
宁静. 顺畅. 耐用

FEATURE
International advanced spray-paint technology.
nontoxic environment
Prevent the corrosion and rust effectively 50000
cycleSo. Tranquility, smooth durability

可选择颜色 **Optional color**

- | | |
|-----|---|
| 12" |  |
| 10" |  |
| 8" |  |
| 6" |  |
- | | | | |
|-------|-------|-------|-------|
| ● 12" | 295mm | ● 10" | 245mm |
| ● 8" | 180mm | ● 6" | 158mm |

可选择颜色 **Optional color**

- | | | | | |
|-----------|---|----------|-----------|-----------|
| B |  | ● 亚黑 (B) | ● 香槟色 (C) | ● 金色 (GO) |
| C |  | ● 银色 (S) | ● 灰色 (GR) | ● 亮白 (W) |
| GO |  | | | |
| S |  | | | |
| GR |  | | | |
| W |  | | | |

- ★ Usage: turn on the steam-driven support
- ★ Force Specifications: 30N-150N
- ★ Application: make the right turn on the weight of wooden | aluminum frame doors reveal a steady rate slowly upward.
- ★ 产品用途: 气动上翻支撑
- ★ 举力规格: 30N-150N
- ★ 用途说明: 可使合适重量的上翻木门 / 铝框门稳定速度慢慢向上翻起。

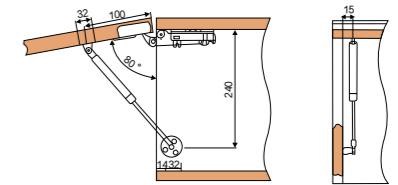

- ★ Uses: Hydraulic next turn support the
- ★ Application: can the next turn wooden | aluminum door frame slow steady downward turn.
- ★ 产品用途: 液压下翻支撑
- ★ 用途说明: 可使下翻木门 / 铝框门稳定速度缓慢向下翻。

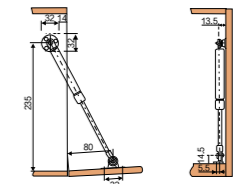

- ★ Usage: turn on the steam-driven support of any stop
- ★ Force Specifications: 50N-120N
- ★ Application: make the right turn on the weight of wooden | aluminum frame door 30° -90° between the opening angle of any intention to stay.
- ★ 产品用途: 气动上翻任意停支撑
- ★ 举力规格: 50N-120N
- ★ 用途说明: 可使合适重量的上翻木门, 铝框门在 30° -90° 的开启角度之间任意停留。

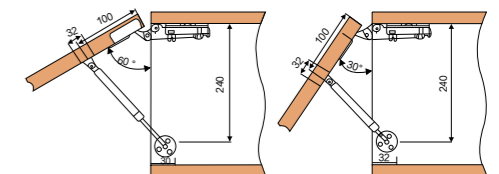

- ★ Uses: Hydraulic Flip Support
- ★ Force Specifications: 30N-150N
- ★ Application: make the right turn on the weight of wooden | aluminum frame door slowly tilting upward, and 60°-90° in the angle created between the opening buffer.
- ★ 产品用途: 液压上翻支撑
- ★ 举力规格: 30N-150N
- ★ 用途说明: 可使合适重量的上翻木门 / 铝框门慢慢向上翻起, 并能在 60° -90° 的开启角度之间产生缓冲作用。

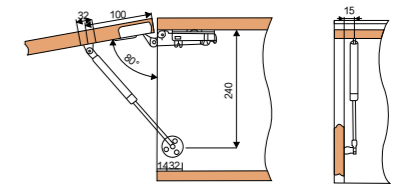

可选配件类型 **Optional accessories**

A3 (长孔铝门配件)

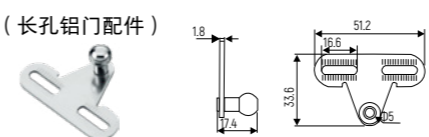

A5 (圆孔铝门配件)

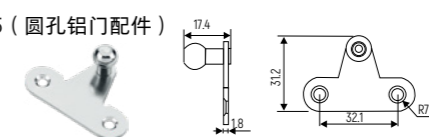

A4 (定位圆配件)

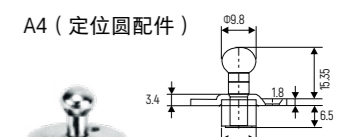

A6 (直角铝门配件)

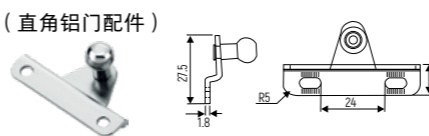



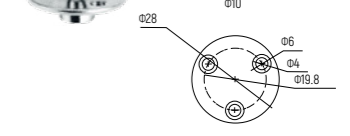
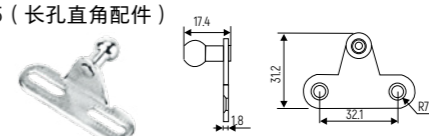

A5 (长孔直角配件)





CM 278

-  支撑力: 30N-150N
Force: 30N-150N
-  杆表面处理: 镀硬铬
Finish: Rigid chromium-plating





-  管表面处理: 镀铬、喷漆
Finish: Chromium-plating spray-paint
-  主要材质: 塑料、铁、铜
Main material: pom / iron / copper
-  包装数量: 100套 / 箱
Packing: 100pcs/CTN

- ★ Center: 245mm
- ★ Stroke: 90mm
- ★ Force: 30N -150N
- ★ Function: support, up, down, free stop, double step close
- ★ 中心距: 245mm
- ★ 行程: 90mm
- ★ 支撑力: 30N-150N
- ★ 可选功能: 上翻门支撑、下翻门缓冲、上翻门任意停、上翻门缓冲





产品特性
采用国际先进喷漆技术, 无毒环保。
有效防止腐蚀及生锈, 使用寿命达 50000 次。
宁静. 顺畅. 耐用

FEATURE
International advanced spray-paint technology.
nontoxic environment
Prevent the corrosion and rust effectively 50000
cycleSo.Tranquility, smooth.durability

可选择颜色 **Optional color**

- 12" 
 - 10" 
 - 8" 
 - 6" 
- 12" 295mm ● 10" 245mm
● 8" 180mm ● 6" 158mm

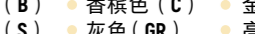
可选择颜色 **Optional color**

- B 
 - C 
 - GO 
 - S 
 - GR 
 - W 
- 亚黑 (B) ● 香槟色 (C) ● 金色 (GO)
● 银色 (S) ● 灰色 (GR) ● 亮白 (W)



CM 278A

- ★ Usage: turn on the steam-driven support
- ★ Force Specifications: 30N-150N
- ★ Application: make the right turn on the weight of wooden I aluminum frame doors reveal a steady rate slowly upward.
- ★ 产品用途: 汽动上翻支撑
- ★ 举力规格: 30N-150N
- ★ 用途说明: 可使合适重量的上翻木门 / 铝框门稳定速度慢慢向上翻起。

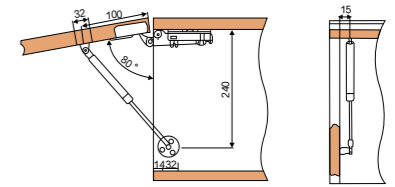

CM 279

- ★ Uses: Hydraulic next turn support the
- ★ Application: can the next turn wooden I aluminum door frame slow steady downward turn.
- ★ 产品用途: 液压下翻支撑
- ★ 用途说明: 可使下翻木门 / 铝框门稳定速度缓慢向下翻。

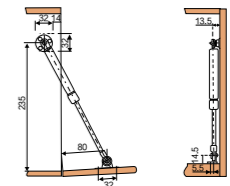

CM 279A

- ★ Usage: turn on the steam-driven support of any stop
- ★ Force Specifications: 50N-120N
- ★ Application: make the right turn on the weight of wooden I aluminum frame door 30° -90° between the opening angle of any intention to stay.
- ★ 产品用途: 汽动上翻任意停支撑
- ★ 举力规格: 50N-120N
- ★ 用途说明: 可使合适重量的上翻木门, 铝框门在 30° -90° 的开启角度之间任意停留。

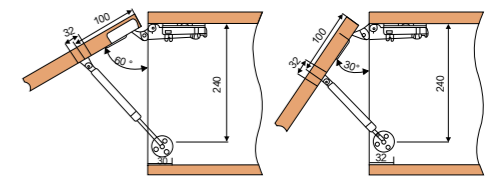

- ★ Uses: Hydraulic Flip Support
- ★ Force Specifications: 30N-150N
- ★ Application: make the right turn on the weight of wooden I aluminum frame door slowly tilting upward, and 60°-90° in the angle created between the opening buffer.
- ★ 产品用途: 液压上翻支撑
- ★ 举力规格: 30N-150N
- ★ 用途说明: 可使合适重量的上翻木门 / 铝框门慢慢向上翻起, 并能在 60° -90° 的开启角度之间产生缓冲作用。

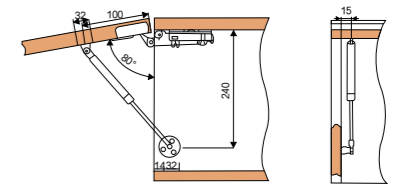

可选配件类型 **Optional accessories**

A3 (长孔铝门配件)

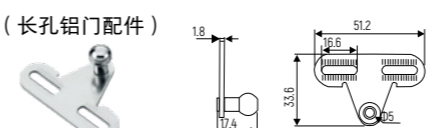

A5 (圆孔铝门配件)

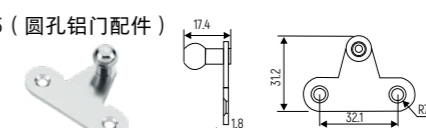

A4 (定位圆配件)

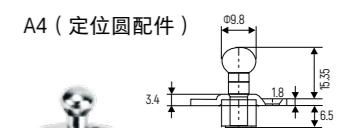

A6 (直角铝门配件)

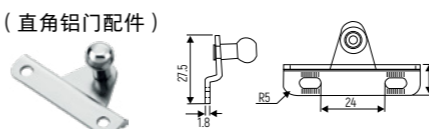

A5 (长孔直角配件)

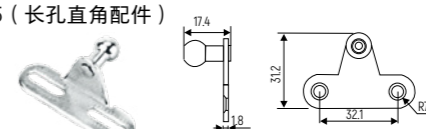

CM 280

表面处理: 喷漆 / 喷粉
主要材质: 铁
尺寸选择: 600-1500mm
管体选择: 15 #、18 #、
22 #、25 #、27 # 精密无缝钢管
适用范围: 多种用途
Finish: Painting/Powder
Materials: Iron
Tube body: 15 #、18 #、22 #、25 #、27 #
Precision seamless steel tubes
Available: Multi-purpose



气动强簧架系列以高压惰性气体为动力, 在整个工作行程中保持恒定的支撑力, 并具有缓冲设计, 避免了到位的冲击, 这优越于普通弹簧的最大特点, 并具有安装方便, 使用安全无需保养等优点。系列产品用于构件提升、支撑、重力的平衡和代替精良设备的机械强簧等, 具有安全可靠、力值一致、不渗漏气、使用寿命长等特点。现已广泛应用于家具、汽车引擎盖后门的开启, 绘图机、航空货架、印刷机械、食品加工及现代自动化的机械设备、健身器材、纺织、木工机械等领域。

Pneumatic strong spring frame series is powered by high-pressure inert gas, maintains constant support force throughout the working stroke, and has a buffer design to avoid the impact in place, which is superior to ordinary springs. The biggest features, and has the advantages of easy installation, safe use, no maintenance, etc. The series products are used for lifting, support balance of gravity, and mechanical strength springs that replace advanced equipment. Full reliability, consistent force value, no leakage, long service life, etc. It has been widely used in the opening of furniture, car hood/back doors, plotters, aviation shelves, printing machinery, and food products. Machines and modern automated machinery equipment fitness equipment, textiles, woodworking machinery and other fields.

安装使用说明 installation instructions

1. 平行片安装必须与呈水平状态的角片保持一定的夹角, 夹角越大, 效果越佳, 如图所示。
2. 气弹簧, 举升器必须安装在床上, 双手用 120kg 的力量平行往下压。(气弹簧无开关, 不能取下压)
3. 气弹簧必须按图所示安装, 不能倒置安装。

1. Flat plate must be installed with angle plate, and keep the correct Angle, as better. (See photo)
2. Gas spring, Gas lift must be installed on the bed. Using the power of 120KGS by hands and press down. (Remark: there is no switch, can't take out the lift)
3. Gas spring must be installed like the photo, other ways are not workable

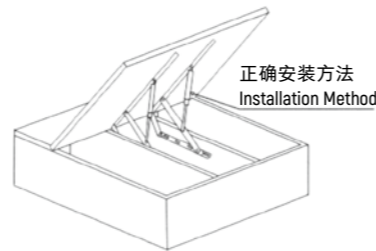

尺寸 Size	气撑尺寸 Gas Spring Size	钢板厚度 Steel Plate Thickness(mm)			
		A	B	C	D
600mm	22x317mm	28x32x2.5(3.0/3.5/4.0/4.5/5.0/5.0/6.0)	110x28x4.0	300x28x4.0	450x24x4.0
900mm	22x531mm	28x32x3.0(3.5/4.0/4.5/5.0/5.5/6.0)	170x28x6.0	460x28x6.0	620x24x4.0
1000mm	22x531mm	28x32x3.0(3.5/4.0/4.5/5.0/5.5/6.0)	170x28x6.0	460x28x6.0	620x24x4.0
1100mm	22x531mm	28x32x3.0(3.5/4.0/4.5/5.0/5.5/6.0)	170x28x6.0	460x28x6.0	620x24x4.0
1200mm	22x531mm	28x32x3.0(3.5/4.0/4.5/5.0/5.5/6.0)	170x28x6.0	460x28x6.0	620x24x4.0
1500mm	22x531mm	28x32x3.0(3.5/4.0/4.5/5.0/5.5/6.0)	170x28x6.0	460x28x6.0	620x24x4.0

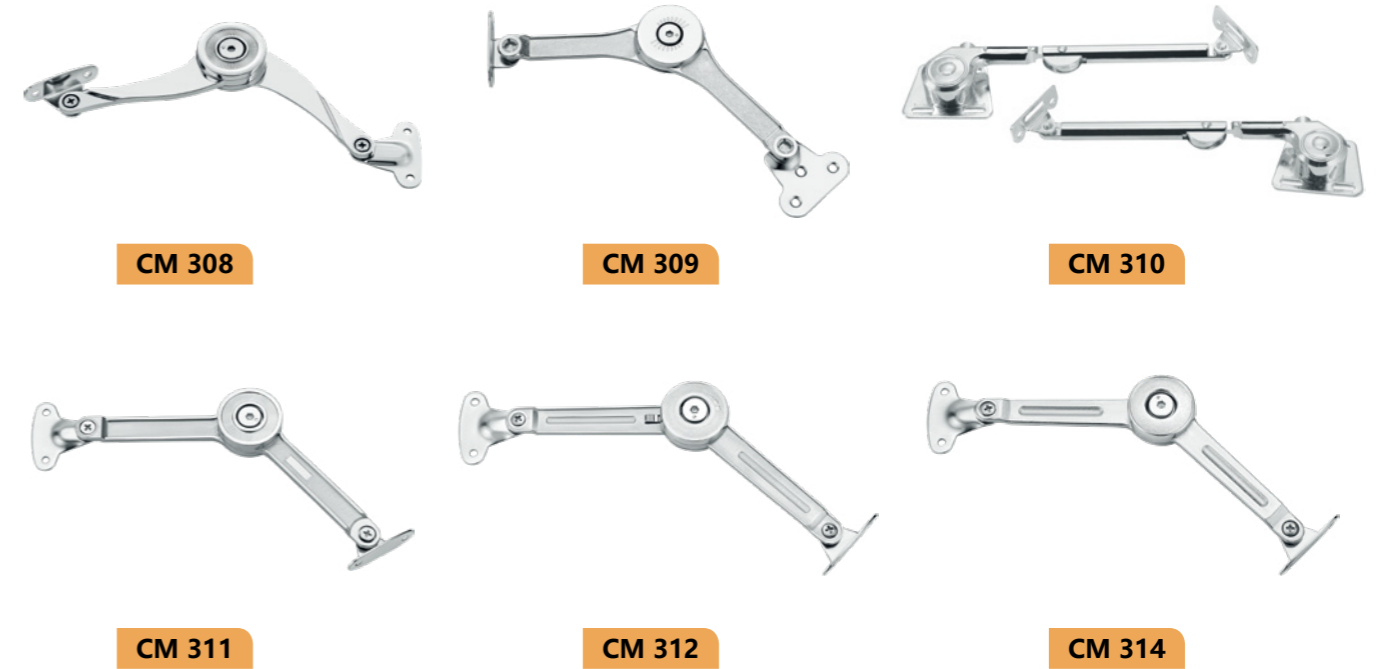

使用特点:

用于橱柜的上翻木门和铝柜门。
开启角度: 通过改变安装尺寸, 上翻门最大开启角度可调整在 75°, 90° 和 105° 位置。
上翻门在开启到最大开启角度可停住, 其他任意位置为随意停状态及门板在任意位置可以停住。
调节中心六角螺丝可承受不同重量的门板, 达到最佳效果。

Application features:

Used in up-turn kitchen cabinet wooden door and aluminum cabinet door.
Opening angle: By changing installation dimensions, up-turn door max. opening angle can be adjusted at 75°, 90° and 105° positions.
Up-turn door can stop when opened to max. opening angle. Other positions are random stop state and door panel can stop at any position.
Through adjustment of center hex screw, it can bear different door panels of different weight, achieving best performance.

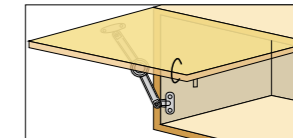

标准技术表 Standard Technical Information

表面处理: 镀铬
Finish: Chromium-plating

主要材质: 锌合金
Materials: Zinc alloy

最大承重: 20kg
Max weight: 20kg

适用范围: 各种柜门
Available for: All kinds of cabinet doors

特性: 支撑柜门板
Features: Supporting cabinet doors

安装孔位示意图
Installation indication

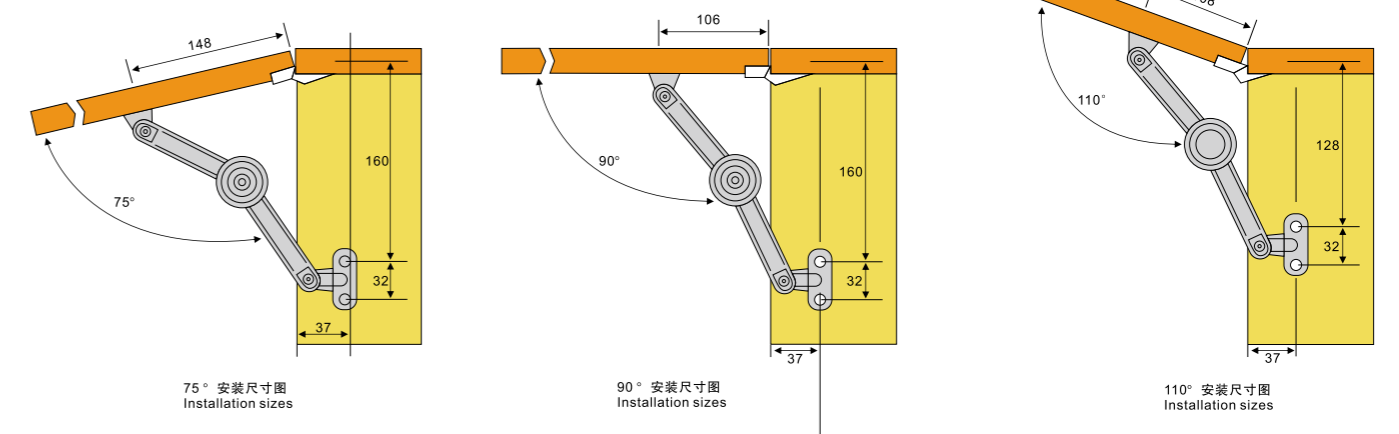



表面处理: 亮光、砂光
Finish: lighting, sanding

产品材质: 锌合金
Material: Zinc alloy

适用范围: 钢化玻璃门
Available For: toughened Glass door

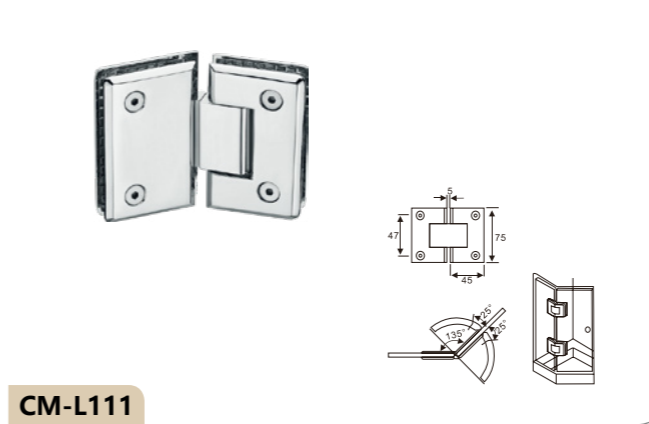

CM-L111

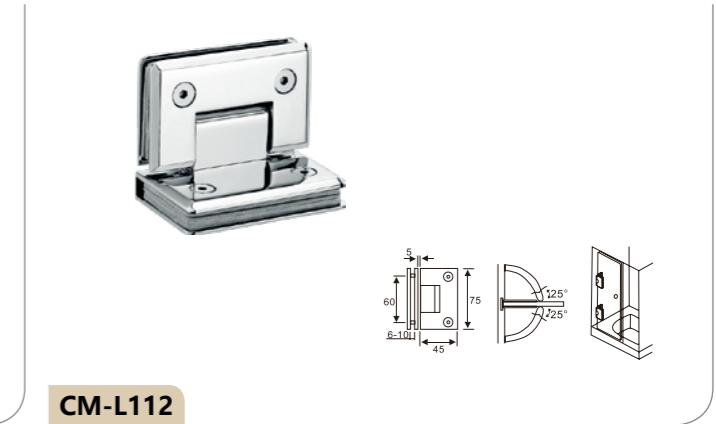

CM-L112

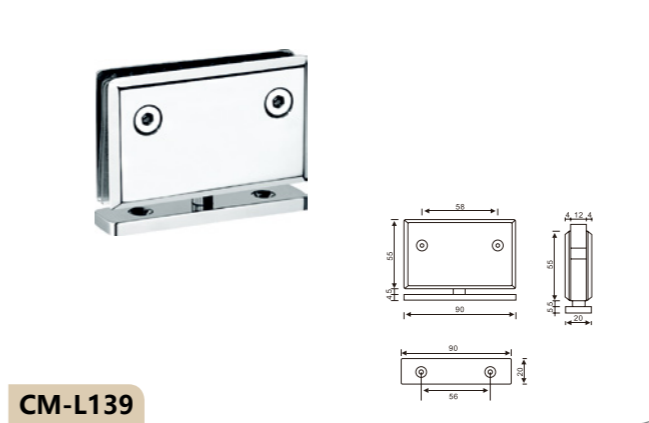

CM-L139

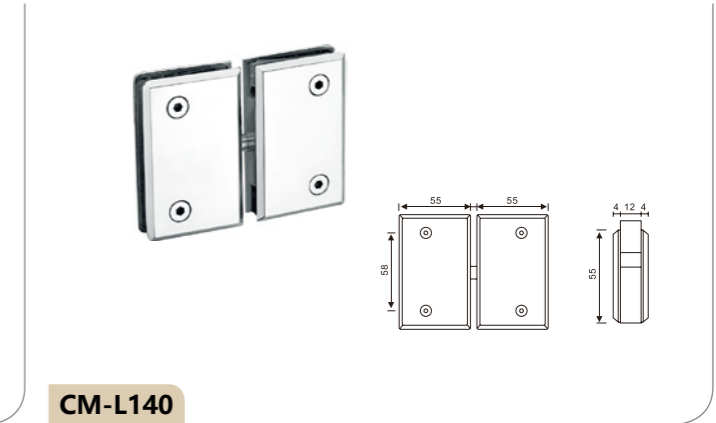

CM-L140

表面处理: 亮光、砂光
Finish: lighting, sanding

产品材质: 锌合金
Material: Zinc alloy

适用范围: 钢化玻璃门
Available For: toughened Glass door

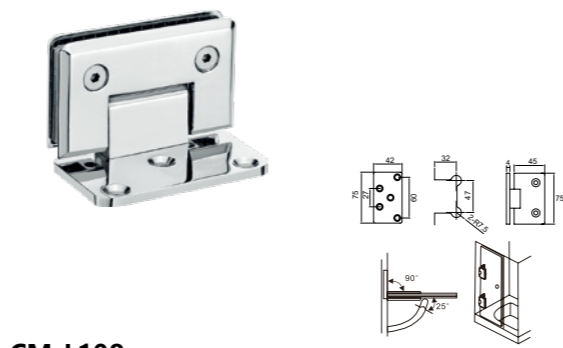

CM-L108

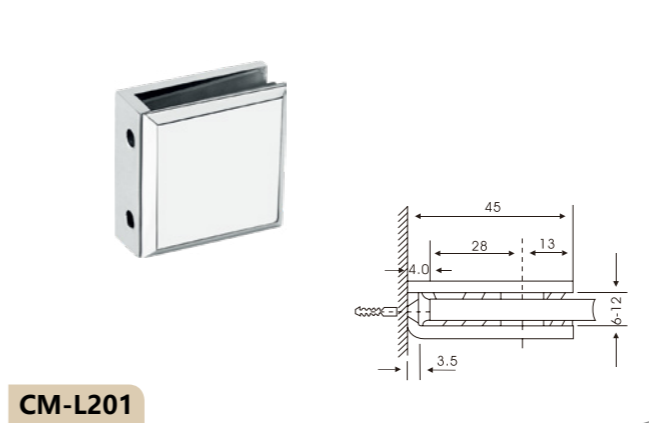

CM-L201

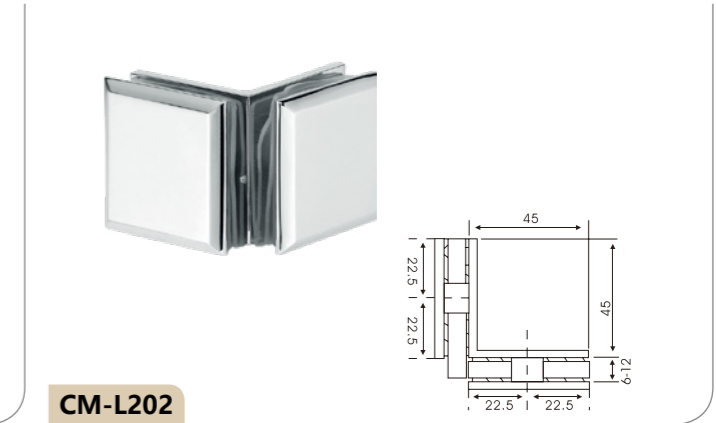

CM-L202

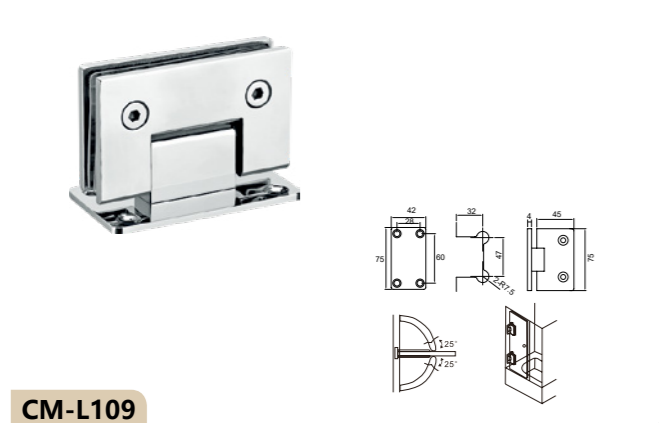

CM-L109

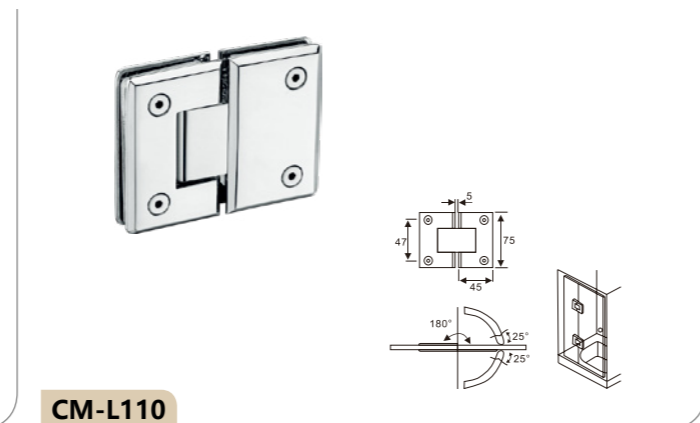

CM-L110

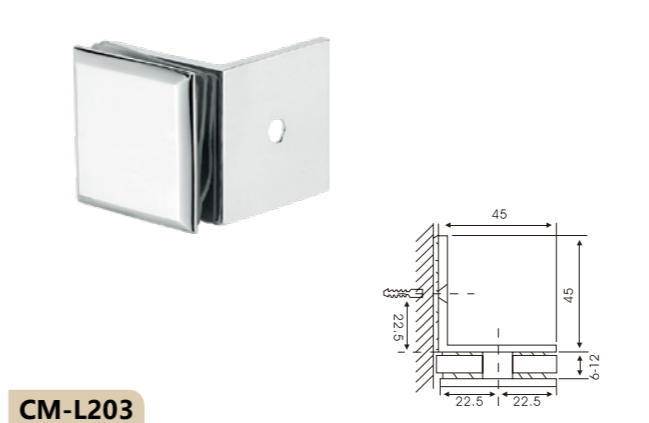

CM-L203

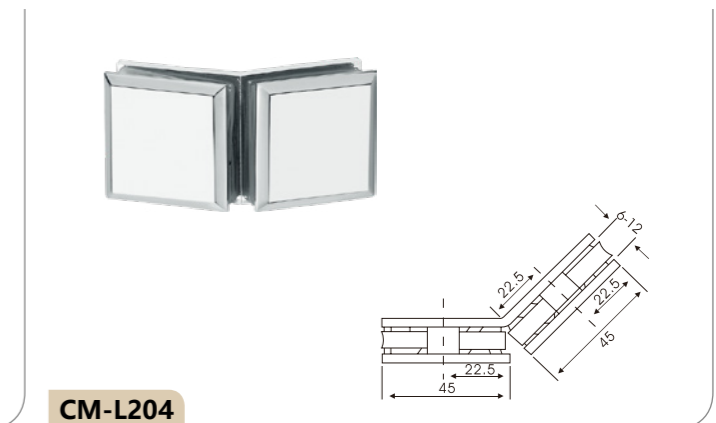

CM-L204

表面处理: 亮光、砂光
 Finish: lighting, sanding

产品材质: 锌合金
 Material: Zinc alloy

适用范围: 钢化玻璃门
 Available For: toughened Glass door

表面处理: 亮光、砂光
 Finish: lighting, sanding

产品材质: 锌合金
 Material: Zinc alloy

适用范围: 钢化玻璃门
 Available For: toughened Glass door

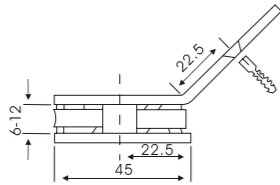

CM-L205

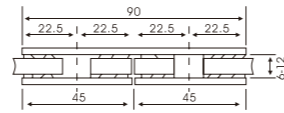

CM-L206

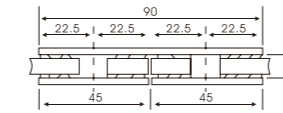

CM-L213

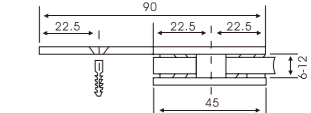

CM-L214

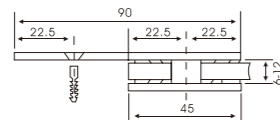

CM-L207

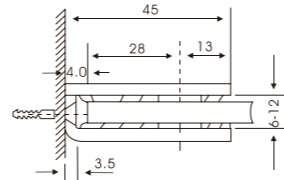

CM-L208

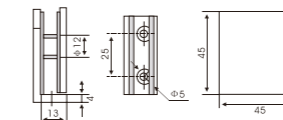

CM-L215

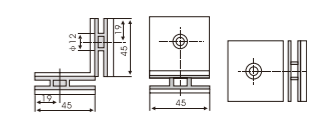

CM-L216

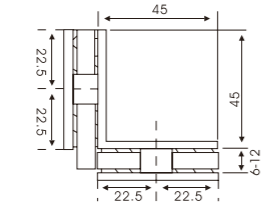

CM-L209

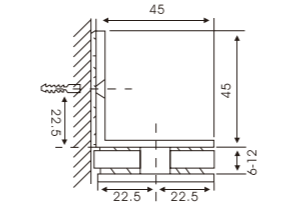

CM-L210

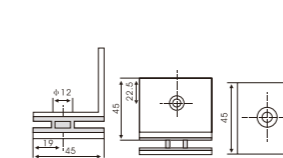

CM-L217

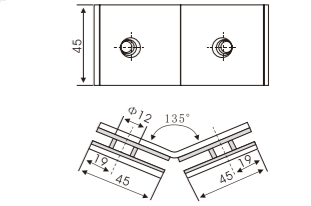

CM-L218

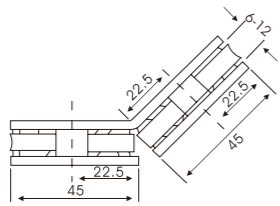

CM-L211

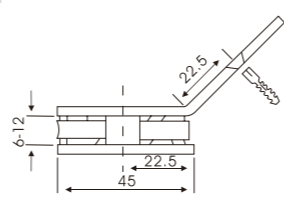

CM-L212

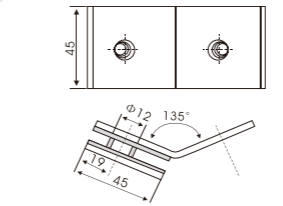

CM-L219

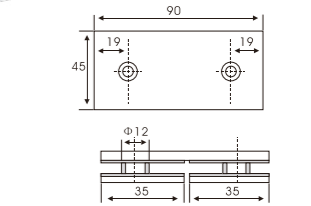

CM-L220

表面处理: 亮光、砂光
Finish: lighting, sanding

产品材质: 锌合金
Material: Zinc alloy

适用范围: 钢化玻璃门
Available For: toughened Glass door

表面处理: 亮光、砂光
Finish: lighting, sanding

产品材质: 精铸不锈钢
Material: Casting stainless steel

适用范围: 钢化玻璃门
Available For: toughened Glass door

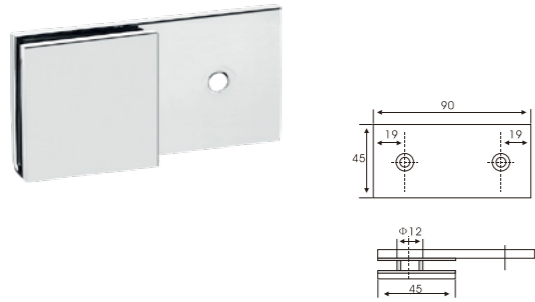

CM-L221

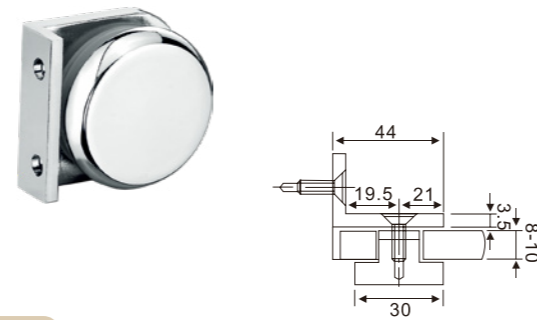

CM-L222

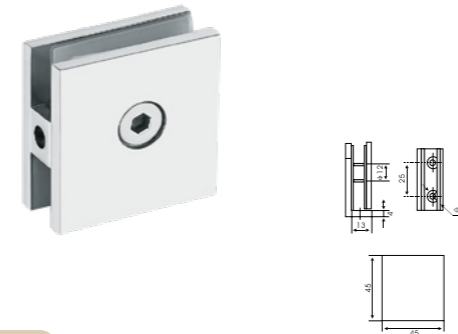

CM-G001

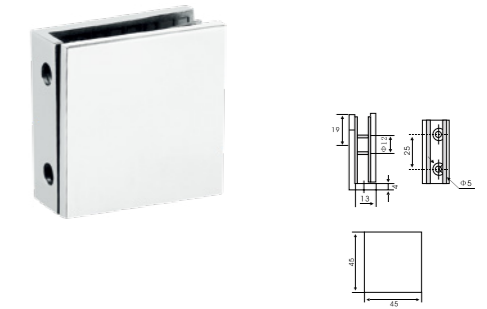

CM-G002

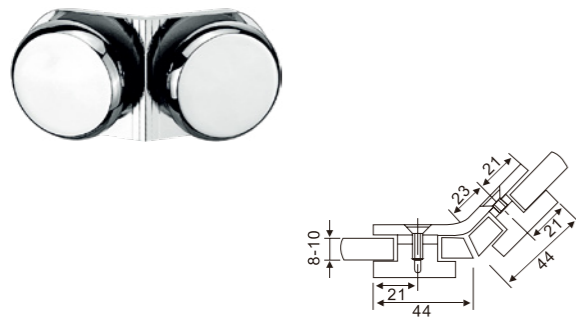

CM-L223

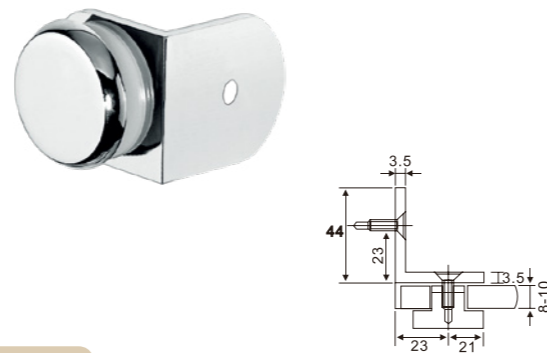

CM-L224

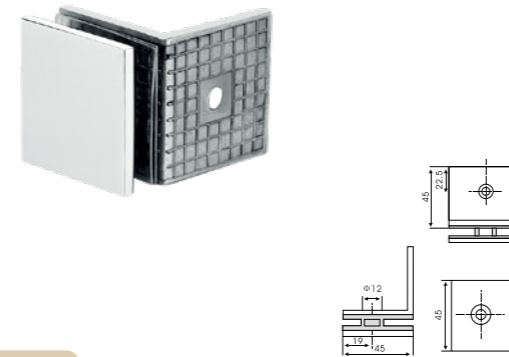

CM-G003

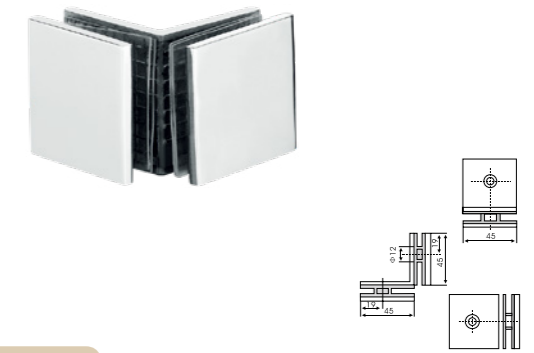

CM-G004

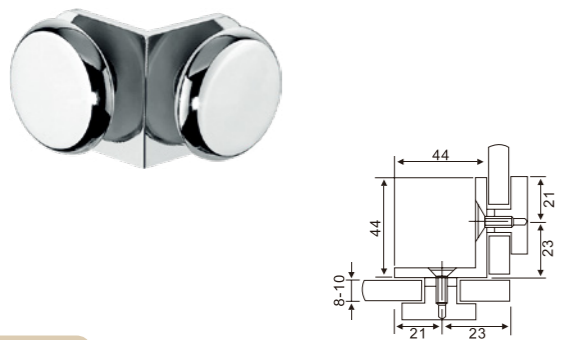

CM-L225

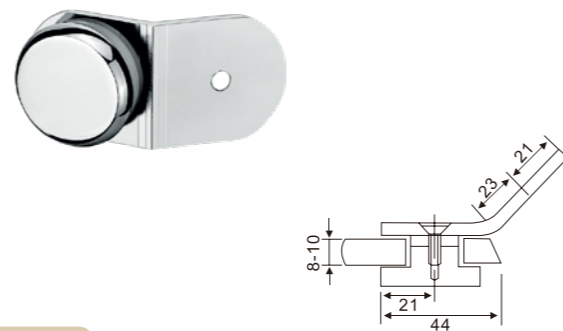

CM-L226

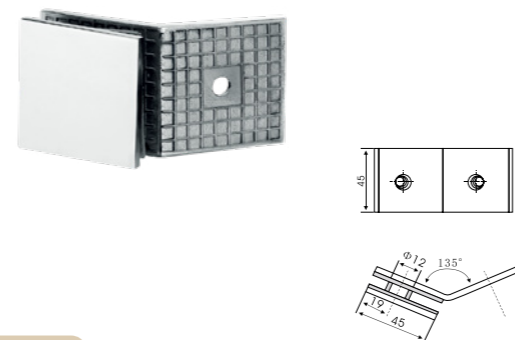

CM-G005

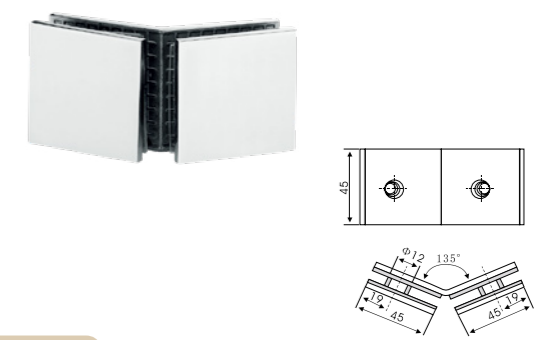

CM-G006

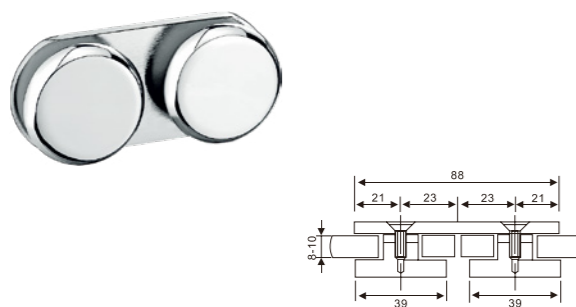

CM-L227

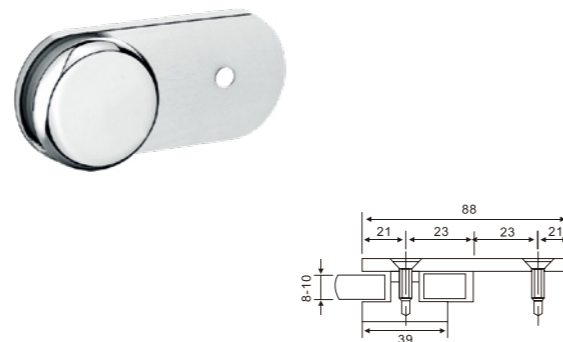

CM-L228

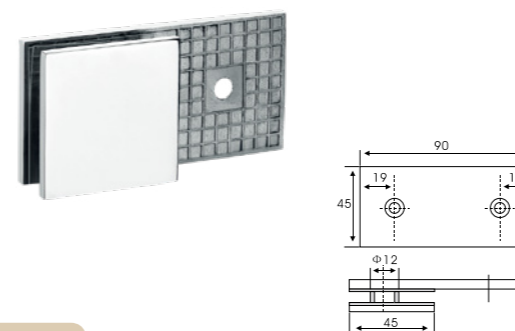

CM-G007

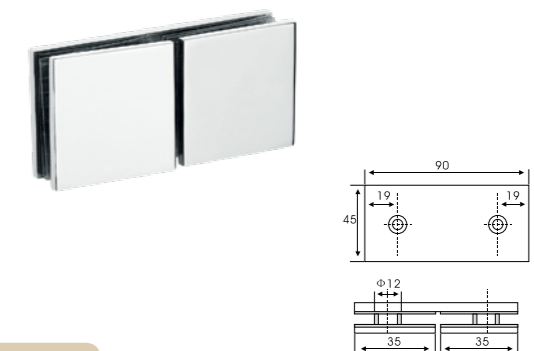

CM-G008

表面处理: 亮光、砂光
Finish: lighting, sanding

产品材质: 精铸不锈钢
Material: Casting stainless steel

适用范围: 钢化玻璃门
Available For: toughened Glass door

表面处理: 亮光、砂光
Finish: lighting, sanding

产品材质: 精铸不锈钢
Material: Casting stainless steel

适用范围: 钢化玻璃门
Available For: toughened Glass door

CM-G009

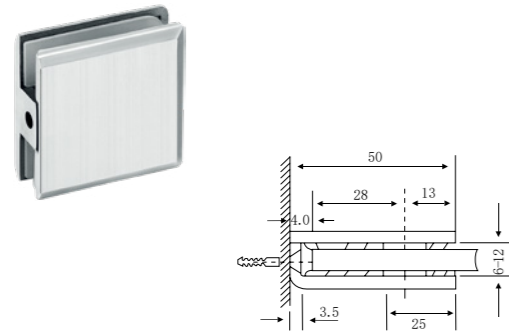

CM-G010

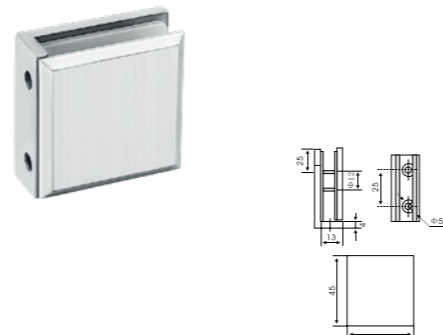

CM-G017

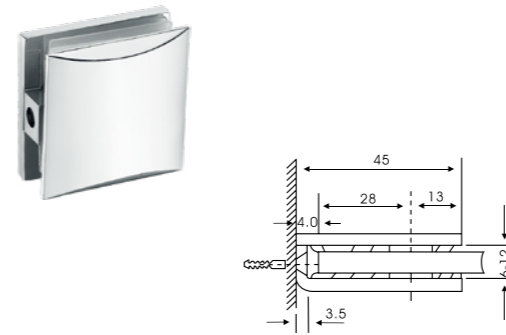

CM-G018

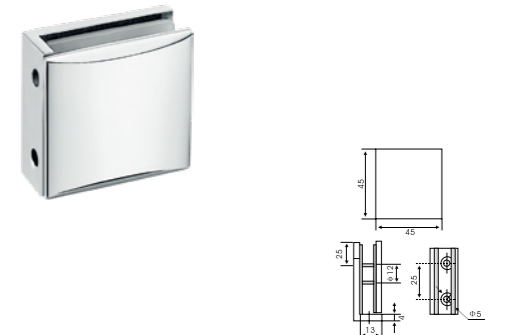

CM-G011

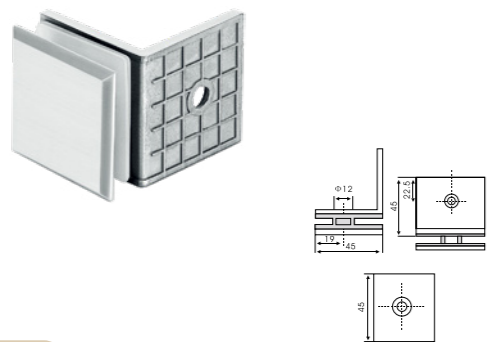

CM-G012

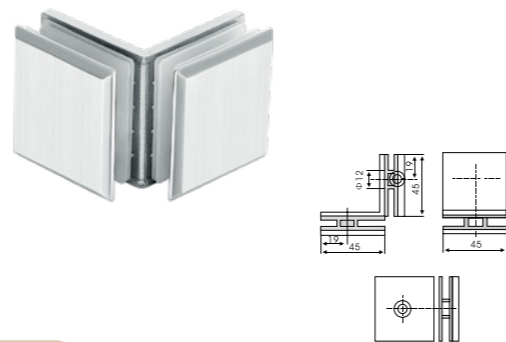

CM-G019

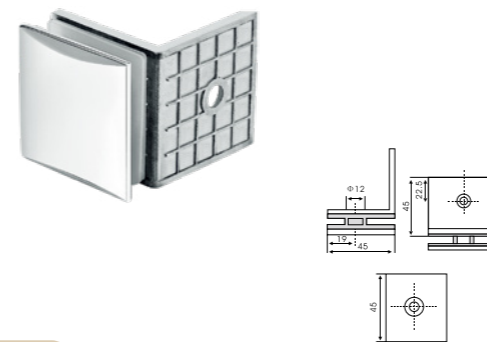

CM-G020

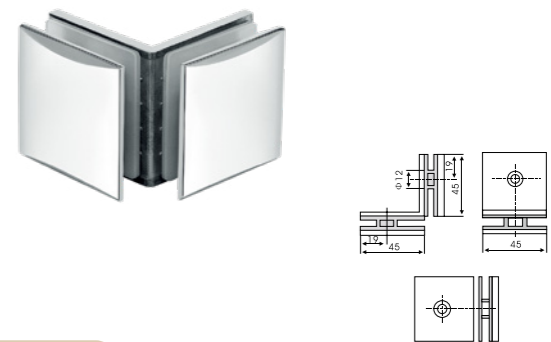

CM-G013

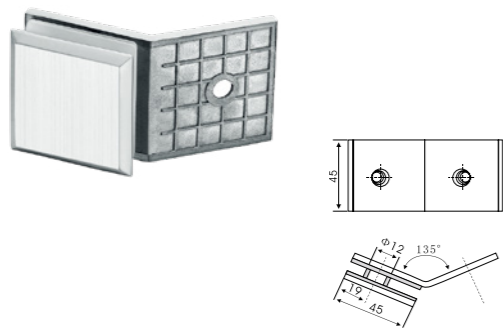

CM-G014

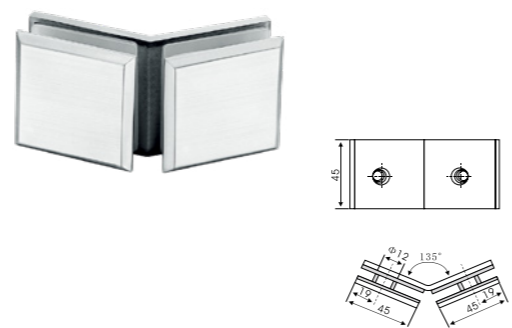

CM-G021

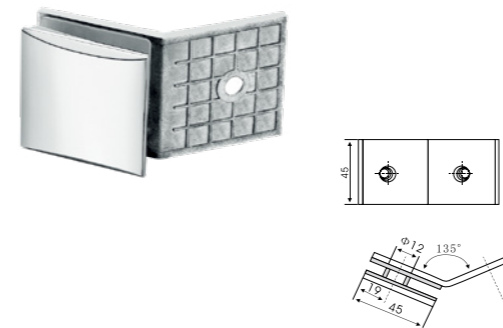

CM-G022

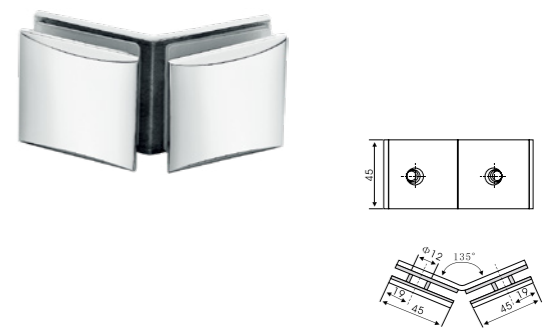

CM-G015

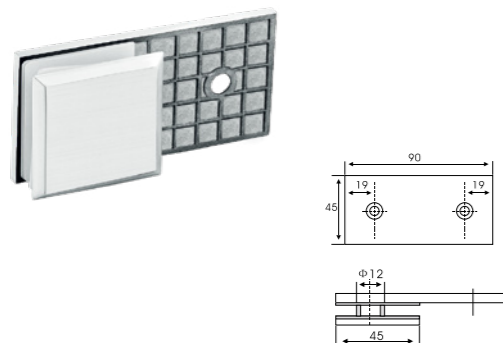

CM-G016

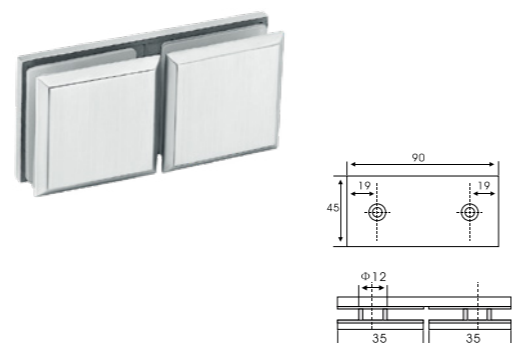

CM-G023

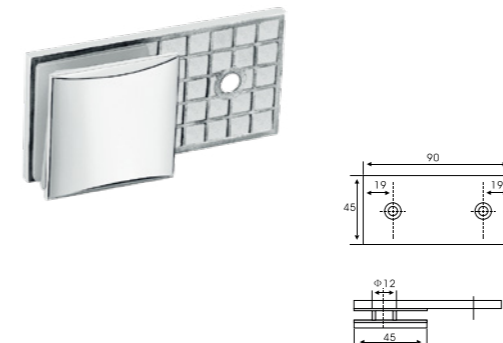

CM-G024

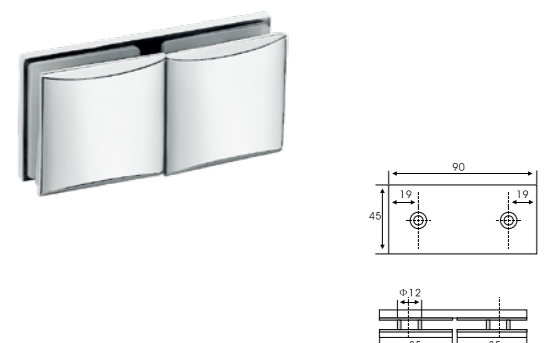



- 材质: 不锈钢
Material: Stainless steel
- 表面处理: 拉丝、亮光
Finish: Satin, Polish
- 玻璃厚度: 8-10mm
Glass thickness: 8-10mm

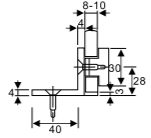

CM 883 弧形 90° 单圆珠隔断码



- 材质: 不锈钢
Material: Stainless steel
- 表面处理: 拉丝、亮光
Finish: Satin, Polish
- 玻璃厚度: 8-10mm
Glass thickness: 8-10mm

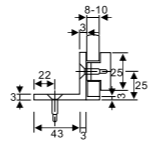

CM 888 圆形 90° 单圆珠隔断码

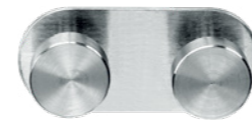

- 材质: 不锈钢
Material: Stainless steel
- 表面处理: 拉丝、亮光
Finish: Satin, Polish
- 玻璃厚度: 8-10mm
Glass thickness: 8-10mm

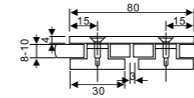

CM 887 圆形 180° 双圆珠隔断码



- 材质: 不锈钢
Material: Stainless steel
- 表面处理: 拉丝、亮光
Finish: Satin, Polish
- 玻璃厚度: 8-10mm
Glass thickness: 8-10mm

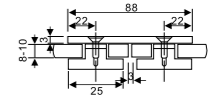

CM 892 弧形 180° 双圆珠隔断码



- 材质: 不锈钢
Material: Stainless steel
- 表面处理: 拉丝、亮光
Finish: Satin, Polish
- 玻璃厚度: 8-10mm
Glass thickness: 8-10mm

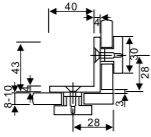

CM 884 弧形 90° 双圆珠隔断码



- 材质: 不锈钢
Material: Stainless steel
- 表面处理: 拉丝、亮光
Finish: Satin, Polish
- 玻璃厚度: 8-10mm
Glass thickness: 8-10mm

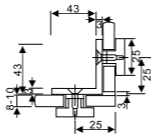

CM 889 圆形 90° 双圆珠隔断码



- 材质: 不锈钢
Material: Stainless steel
- 表面处理: 拉丝、亮光
Finish: Satin, Polish
- 玻璃厚度: 8-10mm
Glass thickness: 8-10mm

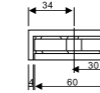

CM 894 0° 隔断码



- 材质: 不锈钢
Material: Stainless steel
- 表面处理: 拉丝、亮光
Finish: Satin, Polish
- 玻璃厚度: 8-10mm
Glass thickness: 8-10mm

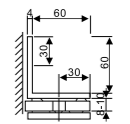

CM 895 90° 单边隔断码



- 材质: 不锈钢
Material: Stainless steel
- 表面处理: 拉丝、亮光
Finish: Satin, Polish
- 玻璃厚度: 8-10mm
Glass thickness: 8-10mm

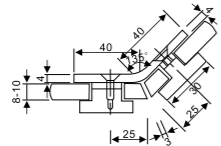

CM 885 弧形 180° 双圆珠隔断码



- 材质: 不锈钢
Material: Stainless steel
- 表面处理: 拉丝、亮光
Finish: Satin, Polish
- 玻璃厚度: 8-10mm
Glass thickness: 8-10mm

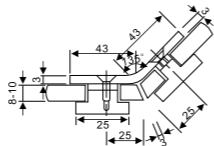

CM 890 圆形 180° 双圆珠隔断码



- 材质: 不锈钢
Material: Stainless steel
- 表面处理: 拉丝、亮光
Finish: Satin, Polish
- 玻璃厚度: 8-10mm
Glass thickness: 8-10mm

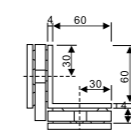

CM 896 90° 双边隔断码



- 材质: 不锈钢
Material: Stainless steel
- 表面处理: 拉丝、亮光
Finish: Satin, Polish
- 玻璃厚度: 8-10mm
Glass thickness: 8-10mm

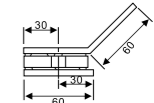

CM 897 135° 单边隔断码



- 材质: 不锈钢
Material: Stainless steel
- 表面处理: 拉丝、亮光
Finish: Satin, Polish
- 玻璃厚度: 8-10mm
Glass thickness: 8-10mm

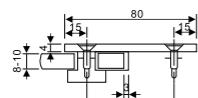

CM 886 圆形 180° 单圆珠隔断码



- 材质: 不锈钢
Material: Stainless steel
- 表面处理: 拉丝、亮光
Finish: Satin, Polish
- 玻璃厚度: 8-10mm
Glass thickness: 8-10mm

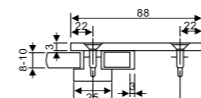

CM 891 弧形 180° 单圆珠隔断码



- 材质: 不锈钢
Material: Stainless steel
- 表面处理: 拉丝、亮光
Finish: Satin, Polish
- 玻璃厚度: 8-10mm
Glass thickness: 8-10mm

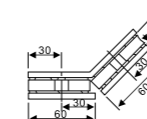

CM 898 135° 双边隔断码



- 材质: 不锈钢
Material: Stainless steel
- 表面处理: 拉丝、亮光
Finish: Satin, Polish
- 玻璃厚度: 8-10mm
Glass thickness: 8-10mm

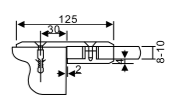

CM 899 180° 单边隔断码



- 材质: 不锈钢
Material: Stainless steel
- 表面处理: 拉丝、亮光
Finish: Satin, Polish
- 玻璃厚度: 8-10mm
Glass thickness: 8-10mm

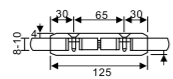

CM 928 180° 双边隔断码



- 材质: 不锈钢
Material: Stainless steel
- 表面处理: 拉丝、亮光
Finish: Satin, Polish
- 玻璃厚度: 8-10mm
Glass thickness: 8-10mm

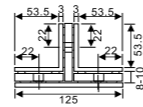

CM 929 T形隔断码



- 材质: 不锈钢
Material: Stainless steel
- 表面处理: 拉丝、亮光
Finish: Satin, Polish
- 玻璃厚度: 6-10mm
Glass thickness: 6-10mm

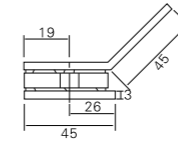

CM 509 135° 单边隔断码



- 材质: 不锈钢
Material: Stainless steel
- 表面处理: 拉丝、亮光
Finish: Satin, Polish
- 玻璃厚度: 6-10mm
Glass thickness: 6-10mm

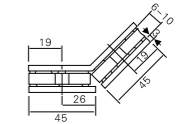

CM 510 135° 双边隔断码



- 材质: 不锈钢
Material: Stainless steel
- 表面处理: 拉丝、亮光
Finish: Satin, Polish
- 玻璃厚度: 8-10mm
Glass thickness: 8-10mm

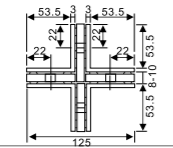

CM 930 十字形隔断码



- 材质: 不锈钢
Material: Stainless steel
- 表面处理: 拉丝、亮光
Finish: Satin, Polish
- 玻璃厚度: 8-10mm
Glass thickness: 8-10mm

H: 60/80/100/120(mm)

CM 294



- 材质: 不锈钢
Material: Stainless steel
- 表面处理: 拉丝、亮光
Finish: Satin, Polish
- 玻璃厚度: 6-10mm
Glass thickness: 6-10mm

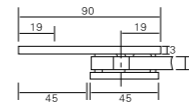

CM 511 180° 单边隔断码



- 材质: 不锈钢
Material: Stainless steel
- 表面处理: 拉丝、亮光
Finish: Satin, Polish
- 玻璃厚度: 6-10mm
Glass thickness: 6-10mm

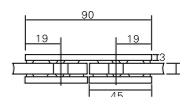

CM 512 180° 双边隔断码



- 材质: 不锈钢
Material: Stainless steel
- 表面处理: 拉丝、亮光
Finish: Satin, Polish
- 玻璃厚度: 8-10mm
Glass thickness: 8-10mm

H: 60/80/100/120(mm)

CM 293



- 材质: 铝合金
Material: Aluminum alloy
- 表面处理: 哑光
Finish: Matt
- 玻璃厚度: 8-10mm
Glass thickness: 8-10mm

H: 80/100/120(mm)

CM 296



- 材质: 不锈钢
Material: Stainless steel
- 表面处理: 拉丝、亮光
Finish: Satin, Polish
- 玻璃厚度: 6-10mm
Glass thickness: 6-10mm

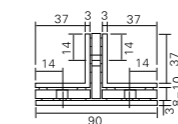

CM 513 T形隔断码



- 材质: 不锈钢
Material: Stainless steel
- 表面处理: 拉丝、亮光
Finish: Satin, Polish
- 玻璃厚度: 6-10mm
Glass thickness: 6-10mm

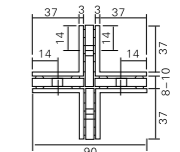

CM 514 十字隔断码



- 材质: 铝合金
Material: Aluminum alloy
- 表面处理: 哑光
Finish: Matt
- 玻璃厚度: 8-10mm
Glass thickness: 8-10mm

H: 80/100/120(mm)

CM 295



- 材质: 不锈钢
Material: Stainless steel
- 表面处理: 拉丝、亮光
Finish: Satin, Polish
- 玻璃厚度: 6-10mm
Glass thickness: 6-10mm

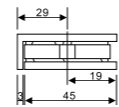

CM 506 0° 隔断码



- 材质: 不锈钢
Material: Stainless steel
- 表面处理: 拉丝、亮光
Finish: Satin, Polish
- 玻璃厚度: 6-10mm
Glass thickness: 6-10mm

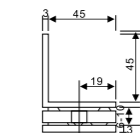

CM 507 90° 单边隔断码



- 材质: 不锈钢
Material: Stainless steel
- 表面处理: 拉丝、亮光
Finish: Satin, Polish
- 玻璃厚度: 6-10mm
Glass thickness: 6-10mm

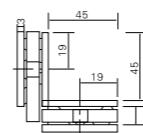

CM 508 90° 双边隔断码



- 材质: 不锈钢
Material: Stainless steel
- 表面处理: 拉丝、亮光
Finish: Satin, Polish
- 玻璃厚度: 10-12mm
Glass thickness: 10-12mm



CM 961





材质: 不锈钢
Material: Stainless steel
规格 Size: 4", 6", 8", 10", 12", 14"
厚度 Thickness: 4.0mm



CM-Y001



材质: 不锈钢
Material: Stainless steel
规格 Size: 6", 8", 10", 12", 14", 16"
厚度 Thickness: 4.0mm



CM-Y002



材质: 不锈钢
Material: Stainless steel
规格 Size: 8", 10", 12", 14"
厚度 Thickness: 4.0mm



CM-Y003



材质: 不锈钢
Material: Stainless steel
规格 Size: 14", 16", 18", 20", 22"



CM-Y004



材质: 不锈钢
Material: Stainless steel
规格 Size: 6", 8", 10", 12", 14", 16"



CM-Y005



材质: 不锈钢
Material: Stainless steel
规格 Size: 6", 8", 10", 12", 14", 16"
厚度 Thickness: 4.0mm



CM-Y006



材质: 不锈钢
Material: Stainless steel
规格 Size: 6", 8", 10", 12", 14", 16"
厚度 Thickness: 4.0mm



CM-Y007



材质: 不锈钢
Material: Stainless steel
规格 Size: 14", 20"
厚度 Thickness: 4.0mm



CM-Y008



材质: 不锈钢
Material: Stainless steel
表面处理: 拉丝
Finish: Satin
厚度 Thickness: 3.0, 4.0mm
规格 Size: 40x20mm, 50x20mm, 60x20mm, 80x20mm, 90x20mm, 100x20mm, 130x20mm, 160x20mm, 180x20mm, 200x20mm, 250x20mm, 300x20mm, 300x25mm

CM-Y009



材质: 不锈钢
Material: Stainless steel
表面处理: 拉丝
Finish: Satin
厚度 Thickness: 3.0, 4.0mm
规格 Size: 20x20mm, 25x20mm, 30x20mm, 40x20mm, 45x20mm, 50x20mm, 65x20mm, 80x20mm, 90x20mm, 100x20mm, 125x20mm, 150x20mm, 150x25mm

CM-Y010



材质: 不锈钢
Material: Stainless steel
表面处理: 拉丝
Finish: Satin
厚度 Thickness: 4.0mm
规格 Size: 150x100x15mm

CM-Y011



材质: 不锈钢
Material: Stainless steel
表面处理: 拉丝
Finish: Satin
厚度 Thickness: 3.0mm
规格 Size: 90x38mm, 130x38mm, 170x38mm

CM-Y012



材质: 不锈钢
Material: Stainless steel
表面处理: 拉丝
Finish: Satin
厚度 Thickness: 3.0mm
规格 Size: 45x38mm, 65x38mm, 85x38mm

CM-Y013



材质: 不锈钢
Material: Stainless steel
表面处理: 拉丝
Finish: Satin
厚度 Thickness: 2.0mm
规格 Size: 90x48mm, 130x48mm, 170x48mm

CM-Y014



材质: 不锈钢
Material: Stainless steel
表面处理: 拉丝
Finish: Satin
厚度 Thickness: 2.0mm
规格 Size: 45x48mm, 65x48mm, 85x48mm

CM-Y015



材质: 不锈钢
Material: Stainless steel
表面处理: 拉丝
Finish: Satin
厚度 Thickness: 3.0mm
规格 Size: 275x45mm, 205x45mm

CM-Y016



材质: 不锈钢
Material: Stainless steel
表面处理: 拉丝
Finish: Satin
厚度 Thickness: 3.0mm
规格 Size: 125x45mm, 175x45mm

CM-Y017



CM 174-8

玻璃厚度: 6-8mm
Glass thickness: 6-8mm

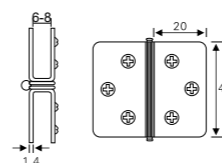

CM 174-10

玻璃厚度: 8-10mm
Glass thickness: 8-10mm

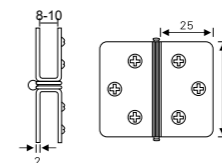

材质: 不锈钢
Material: Stainless steel

表面处理: 拉丝、亮光
Finish: Satin, Polish

适用范围: 玻璃柜门
Available For: Glass cupboard door

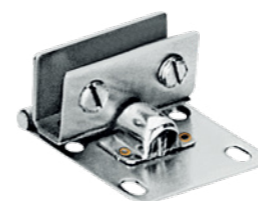

CM 175-8

玻璃厚度: 6-8mm
Glass thickness: 6-8mm

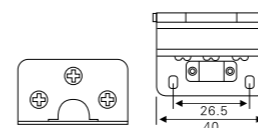

CM 175-10

玻璃厚度: 8-10mm
Glass thickness: 8-10mm

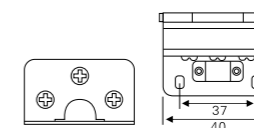

材质: 不锈钢
Material: Stainless steel

表面处理: 拉丝、亮光
Finish: Satin, Polish

适用范围: 玻璃柜门
Available For: Glass cupboard door



CM 177

玻璃厚度: 8-10mm
Glass thickness: 8-10mm

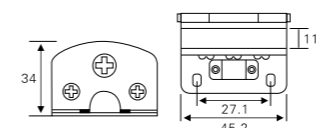

CM 176

玻璃厚度: 8-10mm
Glass thickness: 8-10mm

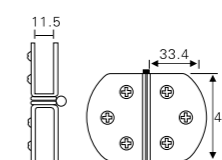

材质: 不锈钢
Material: Stainless steel

表面处理: 拉丝、亮光
Finish: Satin, Polish

适用范围: 玻璃柜门
Available For: Glass cupboard door



CM 612

玻璃厚度: 10mm
Glass thickness: 10mm

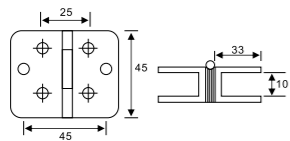

CM 611

玻璃厚度: 10mm
Glass thickness: 10mm

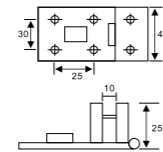

- 材质: 不锈钢
Material: Stainless steel
- 表面处理: 拉丝、亮光
Finish: Satin, Polish
- 适用范围: 玻璃柜门
Available For: Glass cupboard door



CM 182

玻璃厚度: 6-8mm
Glass thickness: 6-8mm

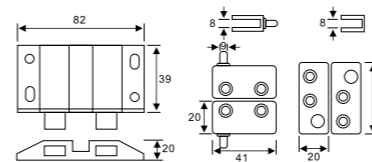

CM 180

玻璃厚度: 6-8mm
Glass thickness: 6-8mm

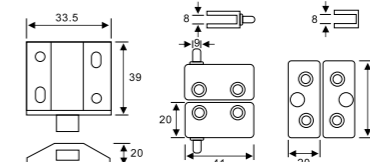

- 材质: 不锈钢
Material: Stainless steel
- 表面处理: 拉丝、亮光
Finish: Satin, Polish
- 适用范围: 玻璃柜门
Available For: Glass cupboard door

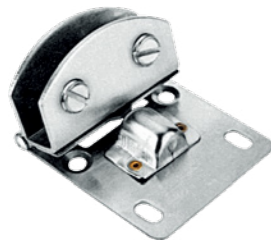

CM 607

玻璃厚度: 6-8mm
Glass thickness: 6-8mm

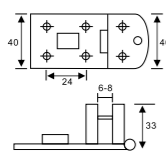

CM 613

玻璃厚度: 10mm
Glass thickness: 10mm

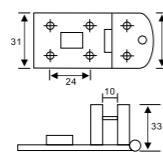

- 材质: 不锈钢
Material: Stainless steel
- 表面处理: 拉丝、亮光
Finish: Satin, Polish
- 适用范围: 玻璃柜门
Available For: Glass cupboard door

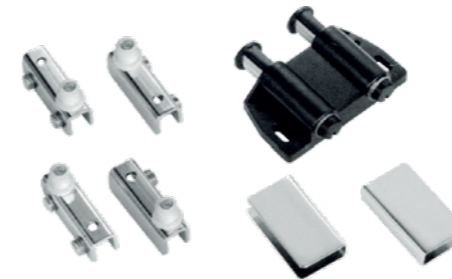

CM 944

玻璃厚度: 6-8mm
Glass thickness: 6-8mm

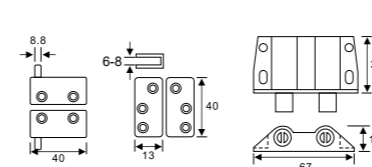

CM 945

玻璃厚度: 6-8mm
Glass thickness: 6-8mm

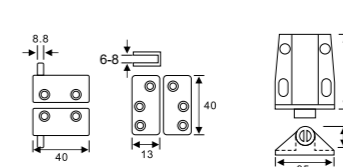

- 材质: 铁
Material: Iron
- 表面处理: 拉丝、亮光
Finish: Satin, Polish
- 适用范围: 玻璃柜门
Available For: Glass cupboard door



CM 616

玻璃厚度: 10mm
Glass thickness: 10mm

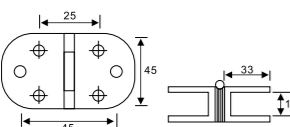

CM 614

玻璃厚度: 10mm
Glass thickness: 10mm

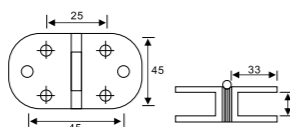

- 材质: 不锈钢
Material: Stainless steel
- 表面处理: 拉丝、亮光
Finish: Satin, Polish
- 适用范围: 玻璃柜门
Available For: Glass cupboard door



CM 946

玻璃厚度: 6-10mm
Glass thickness: 6-10mm

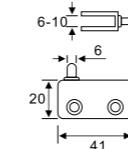

CM 947

玻璃厚度: 10-12mm
Glass thickness: 10-12mm

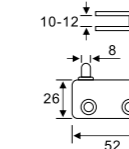

- 材质: 不锈钢
Material: Stainless steel
- 表面处理: 拉丝、亮光
Finish: Satin, Polish
- 适用范围: 玻璃柜门
Available For: Glass cupboard door

CM 601

材质: 水晶
Material: Crystal

表面处理: 白线、黑线、
红线、蓝线
Finish: White, Black, Red, Blue

CM 602

材质: 水晶
Material: Crystal

表面处理: 白线、黑线、
红线、蓝线
Finish: White, Black, Red, Blue

CM 256

材质: 太空铝
Material: Aluminum

表面处理: 拉丝、亮光
Finish: Satin, Polish

CM 262

材质: 太空铝
Material: Aluminum

表面处理: 拉丝、亮光、
亮色
Finish: Satin, Polish

CM 603

材质: 水晶
Material: Crystal

表面处理: 白线、黑线、
红线、蓝线
Finish: White, Black, Red, Blue

CM 604

材质: 水晶
Material: Crystal

表面处理: 白线、黑线、
红线、蓝线
Finish: White, Black, Red, Blue

CM 263

材质: 太空铝
Material: Aluminum

表面处理: 拉丝、亮光
Finish: Satin, Polish

CM 264

材质: 太空铝
Material: Aluminum

表面处理: 拉丝、亮光
Finish: Satin, Polish

CM 242

材质: 太空铝
Material: Aluminum

表面处理: 拉丝、亮光、
金色
Finish: Satin, Polish

CM 243

材质: 太空铝
Material: Aluminum

表面处理: 拉丝、亮光、
亮色
Finish: Satin, Polish

CM 265

材质: 太空铝
Material: Aluminum

表面处理: 拉丝、亮光
Finish: Satin, Polish

CM 267

材质: 太空铝
Material: Aluminum

表面处理: 拉丝、亮光
Finish: Satin, Polish

CM 244

材质: 太空铝、不锈钢
Material: Aluminum, Stainless steel

表面处理: 拉丝、亮光
Finish: Satin, Polish

CM 246

材质: 太空铝、不锈钢
Material: Aluminum, Stainless steel

表面处理: 拉丝、亮光
Finish: Satin, Polish

CM 268

材质: 太空铝
Material: Aluminum

表面处理: 拉丝、亮光
Finish: Satin, Polish

CM 269

材质: 太空铝
Material: Aluminum

表面处理: 拉丝、亮光
Finish: Satin, Polish

CM 247

材质: 太空铝、不锈钢
Material: Aluminum, Stainless steel

表面处理: 拉丝、亮光
Finish: Satin, Polish

CM 252

材质: 太空铝、不锈钢
Material: Aluminum, Stainless steel

表面处理: 拉丝、亮光
Finish: Satin, Polish

CM 270

材质: 太空铝
Material: Aluminum

表面处理: 拉丝、亮光
Finish: Satin, Polish

CM 271

材质: 太空铝
Material: Aluminum

表面处理: 拉丝、亮光
Finish: Satin, Polish



材质: 太空铝
Material: Aluminum
表面处理: 砂银
Finish: Sand silver

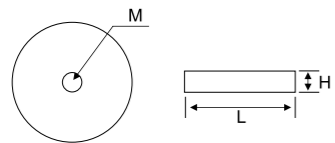

L (mm)			L (mm)		
Φ25	Φ30	M	Φ80	Φ85	M
8mm/10mm/12mm	8mm/10mm/12mm	8mm/10mm/12mm	8mm/10mm/12mm	8mm/10mm/12mm	8mm/10mm/12mm
Φ35	Φ40	M	Φ90	Φ95	M
8mm/10mm/12mm	8mm/10mm/12mm	8mm/10mm/12mm	8mm/10mm/12mm	8mm/10mm/12mm	8mm/10mm/12mm
Φ45	Φ50	M	Φ100	Φ105	M
8mm/10mm/12mm	8mm/10mm/12mm	8mm/10mm/12mm	8mm/10mm/12mm	8mm/10mm/12mm	8mm/10mm/12mm
Φ55	Φ60	M	Φ110	Φ115	M
8mm/10mm/12mm	8mm/10mm/12mm	8mm/10mm/12mm	8mm/10mm/12mm	8mm/10mm/12mm	8mm/10mm/12mm
Φ65	Φ70	M	Φ120	Φ160	M
8mm/10mm/12mm	8mm/10mm/12mm	8mm/10mm/12mm	8mm/10mm/12mm	8mm/10mm/12mm	8mm/10mm/12mm
Φ75		M			
8mm/10mm/12mm		8mm/10mm/12mm			

CM 368



材质: 铜
Material: Brass
表面处理: 亮光、金色
Finish: Chrome、Golden
直径 Diameter: Φ18、Φ20、Φ25、Φ30

CM 015

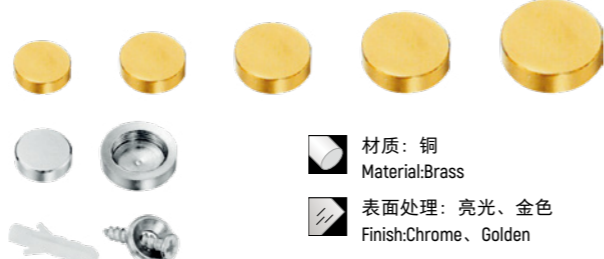

材质: 铜
Material: Brass
表面处理: 亮光、金色
Finish: Chrome、Golden
直径 Diameter: Φ14、Φ16、Φ18、Φ20、Φ22、Φ25、Φ30

CM 016

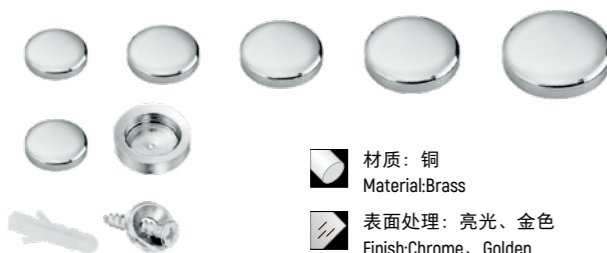

材质: 铜
Material: Brass
表面处理: 亮光、金色
Finish: Chrome、Golden
直径 Diameter: Φ18、Φ20、Φ25、Φ30

CM 017

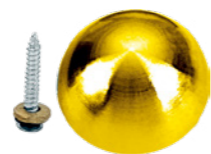

材质: 锌合金
Material: Zinc alloy
表面处理: 金色、银色、沙金、沙银、红古铜、青古铜、珍珠叻、珍珠络
直径 Diameter: Φ18、Φ20、Φ25、Φ30

CM 001

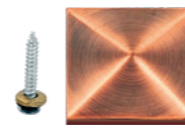

材质: 锌合金
Material: Zinc alloy
表面处理: 金色、银色、沙金、沙银、红古铜、青古铜、珍珠叻、珍珠络
直径 Diameter: Φ20、Φ25、Φ30、Φ40、Φ50、Φ60、Φ80、Φ100

CM 005



材质: 不锈钢
Material: Stainless steel
表面处理: 拉丝
直径 Diameter: Φ12、Φ14、Φ16、Φ18、Φ20、Φ25、Φ30、Φ40、Φ50

CM 013



材质: 锌合金、不锈钢
Material: Zinc alloy、Stainless steel
表面处理: 闪金、闪银、花闪金、花闪银、黑闪金、黑闪银、间蓝、枪黑
直径 Diameter: Φ20、Φ30、Φ40、Φ50、Φ60、Φ80、Φ100

CM 019



材质: 锌合金、不锈钢
Material: Zinc alloy、Stainless steel
表面处理: 闪金、闪银、花闪金、花闪银、黑闪金、黑闪银、间蓝、枪黑
直径 Diameter: Φ20、Φ30、Φ40、Φ50、Φ60、Φ80、Φ100

CM 021



材质: 锌合金、不锈钢
Material: Zinc alloy、Stainless steel
表面处理: 闪金、闪银、花闪金、花闪银、黑闪金、黑闪银、间蓝、枪黑
直径 Diameter: Φ14、Φ16、Φ18、Φ20、Φ22、Φ25、Φ30、Φ40、Φ50

CM 025



材质: 锌合金、不锈钢
Material: Zinc alloy、Stainless steel
表面处理: 闪金、闪银、花闪金、花闪银、黑闪金、黑闪银、间蓝、枪黑
直径 Diameter: Φ14、Φ16、Φ18、Φ20、Φ22、Φ25、Φ30、Φ40、Φ50

CM 028



材质: 锌合金、不锈钢
Material: Zinc alloy、Stainless steel
表面处理: 闪金、闪银、花闪金、花闪银、黑闪金、黑闪银、间蓝、枪黑
直径 Diameter: Φ14、Φ16、Φ18、Φ20、Φ22、Φ25、Φ30、Φ40、Φ50

CM 024



材质: 锌合金、不锈钢
Material: Zinc alloy、Stainless steel
表面处理: 闪金、闪银、花闪金、花闪银、黑闪金、黑闪银、间蓝、枪黑
直径 Diameter: Φ14、Φ16、Φ18、Φ20、Φ22、Φ25、Φ30、Φ40、Φ50

CM 023



材质: 锌合金、不锈钢
Material: Zinc alloy、Stainless steel
表面处理: 闪金、闪银、花闪金、花闪银、黑闪金、黑闪银、间蓝、枪黑
直径 Diameter: Φ14、Φ16、Φ18、Φ20、Φ22、Φ25、Φ30、Φ40、Φ50

CM 031



材质: 锌合金、不锈钢
Material: Zinc alloy、Stainless steel
表面处理: 闪金、闪银、花闪金、花闪银、黑闪金、黑闪银、间蓝、枪黑
直径 Diameter: Φ14、Φ16、Φ18、Φ20、Φ22、Φ25、Φ30、Φ40、Φ50

CM 030



材质: 锌合金、不锈钢
Material: Zinc alloy、Stainless steel
表面处理: 闪金、闪银、花闪金、花闪银、黑闪金、黑闪银、间蓝、枪黑
直径 Diameter: Φ14、Φ16、Φ18、Φ20、Φ25、Φ30、Φ40、Φ50

CM 207



材质: 不锈钢
Material: Stainless steel
表面处理: 拉丝
直径 Diameter: Φ14、Φ16、Φ18、Φ20、Φ25、Φ30、Φ40、Φ50

CM 029



材质: 不锈钢+锌合金
Material: Stainless steel+Zinc alloy
表面处理: 拉丝
Finish: Stainless steel Brushed

CM 3001

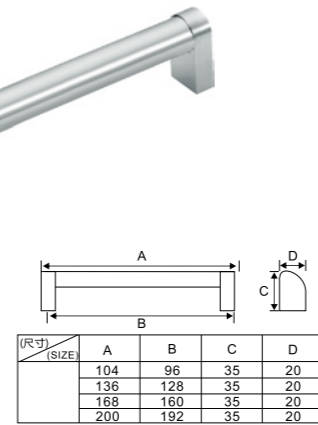

材质: 不锈钢+锌合金
Material: Stainless steel+Zinc alloy
表面处理: 拉丝
Finish: Stainless steel Brushed

CM 3002

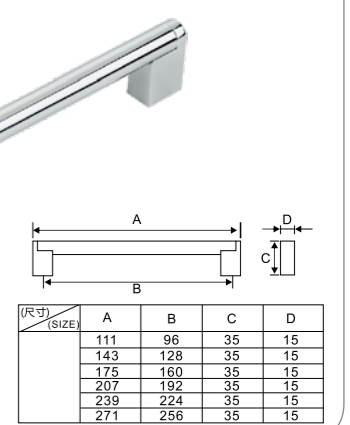

材质: 不锈钢+锌合金
Material: Stainless steel+Zinc alloy
表面处理: 拉丝
Finish: Stainless steel Brushed

CM 3003

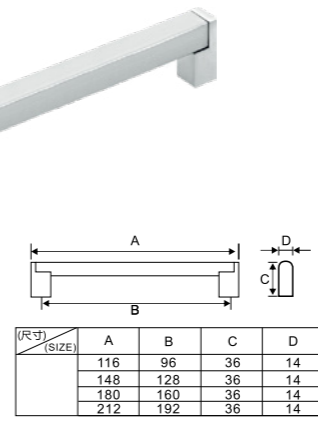

材质: 不锈钢+锌合金
Material: Stainless steel+Zinc alloy
表面处理: 光络、哑络、哑镍、拉丝镍、仿金、古铜、枪黑、喷漆
Finish: Chrome, Matt Chrome, Matt Nickel, Bushed Nickel, Golden, Antique Brass, Gun Black, Painting

CM 3004

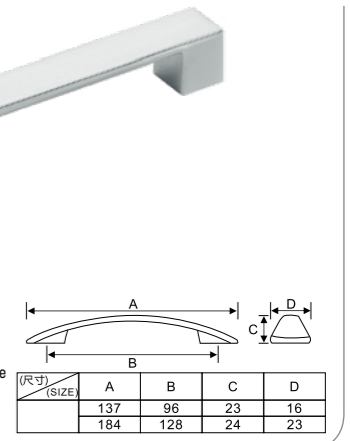

材质: 不锈钢+锌合金
Material: Stainless steel+Zinc alloy
表面处理: 光络、哑络、哑镍、拉丝镍、仿金、古铜、枪黑、喷漆
Finish: Chrome, Matt Chrome, Matt Nickel, Bushed Nickel, Golden, Antique Brass, Gun Black, Painting

CM 3005

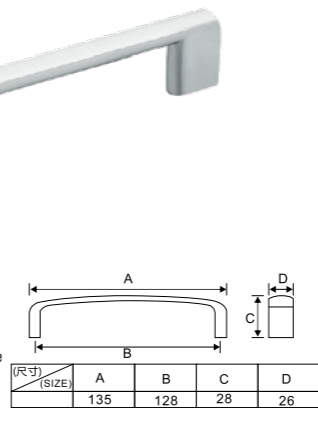

材质: 不锈钢+锌合金
Material: Stainless steel+Zinc alloy
表面处理: 拉丝
Finish: Stainless steel Brushed

CM 3006

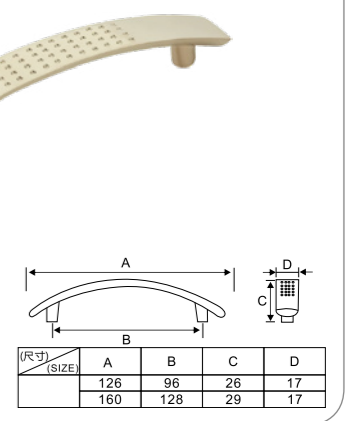

材质: 不锈钢+锌合金
Material: Stainless steel+Zinc alloy
表面处理: 光络、哑络、哑镍、拉丝镍、仿金、古铜、枪黑、喷漆
Finish: Chrome, Matt Chrome, Matt Nickel, Bushed Nickel, Golden, Antique Brass, Gun Black, Painting

CM 3007

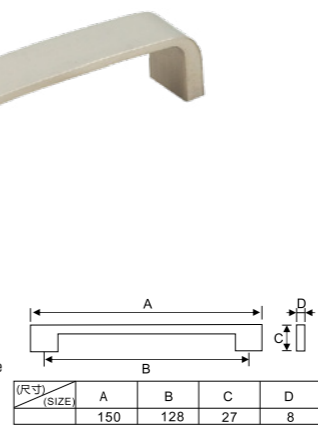

材质: 不锈钢+锌合金
Material: Stainless steel+Zinc alloy
表面处理: 光络、哑络、哑镍、拉丝镍、仿金、古铜、枪黑、喷漆
Finish: Chrome, Matt Chrome, Matt Nickel, Bushed Nickel, Golden, Antique Brass, Gun Black, Painting

CM 3008

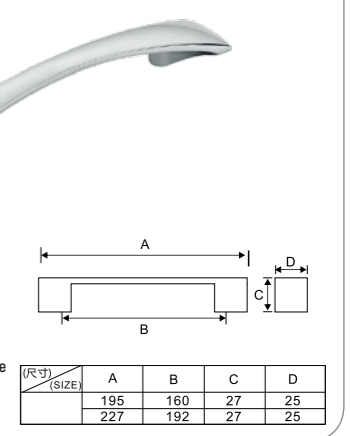



材质: 锌合金
Material: Zinc alloy

表面处理: 光络、哑络、哑镍、拉丝镍、仿金、古铜、枪黑、喷漆
Finish: Chrome, Matt Chrome, Matt Nickel, Bushed Nickel, Golden, Antique Brass, Gun Black, Painting



(尺寸) (SIZE)	A	B	C	D
	113	96	28	11
	146	128	26	11

CM 3009



材质: 锌合金
Material: Zinc alloy

表面处理: 光络、哑络、哑镍、拉丝镍、仿金、古铜、枪黑、喷漆
Finish: Chrome, Matt Chrome, Matt Nickel, Bushed Nickel, Golden, Antique Brass, Gun Black, Painting



(尺寸) (SIZE)	A	B	C	D
	80	64	23	10
	113	96	28	11
	146	128	26	11
	205	160	31	11

CM 3010



材质: 锌合金
Material: Zinc alloy

表面处理: 光络、哑络、哑镍、拉丝镍、仿金、古铜、枪黑、喷漆
Finish: Chrome, Matt Chrome, Matt Nickel, Bushed Nickel, Golden, Antique Brass, Gun Black, Painting



(尺寸) (SIZE)	A	B	C	D
	126	96	23	15
	159	128	26	16

CM 3017



材质: 锌合金
Material: Zinc alloy

表面处理: 光络、哑络、哑镍、拉丝镍、仿金、古铜、枪黑、喷漆
Finish: Chrome, Matt Chrome, Matt Nickel, Bushed Nickel, Golden, Antique Brass, Gun Black, Painting

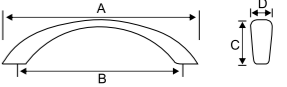

(尺寸) (SIZE)	A	B	C	D
	125	96	23	11
	162	128	23	13

CM 3018



材质: 锌合金
Material: Zinc alloy

表面处理: 光络、哑络、哑镍、拉丝镍、仿金、古铜、枪黑、喷漆
Finish: Chrome, Matt Chrome, Matt Nickel, Bushed Nickel, Golden, Antique Brass, Gun Black, Painting

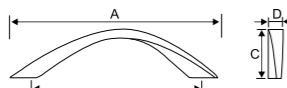

(尺寸) (SIZE)	A	B	C	D
	128	96	26	14
	157	128	24	16

CM 3011



材质: 锌合金
Material: Zinc alloy

表面处理: 光络、哑络、哑镍、拉丝镍、仿金、古铜、枪黑、喷漆
Finish: Chrome, Matt Chrome, Matt Nickel, Bushed Nickel, Golden, Antique Brass, Gun Black, Painting

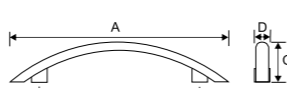

(尺寸) (SIZE)	A	B	C	D
	129.5	96	23	4.9

CM 3012



材质: 锌合金
Material: Zinc alloy

表面处理: 光络、哑络、哑镍、拉丝镍、仿金、古铜、枪黑、喷漆
Finish: Chrome, Matt Chrome, Matt Nickel, Bushed Nickel, Golden, Antique Brass, Gun Black, Painting



(尺寸) (SIZE)	A	B	C	D
	156	128	29	10

CM 3019



材质: 锌合金
Material: Zinc alloy

表面处理: 光络、哑络、哑镍、拉丝镍、仿金、古铜、枪黑、喷漆
Finish: Chrome, Matt Chrome, Matt Nickel, Bushed Nickel, Golden, Antique Brass, Gun Black, Painting



(尺寸) (SIZE)	A	B	C	D
	132	96	24	20

CM 3020



材质: 锌合金
Material: Zinc alloy

表面处理: 光络、哑络、哑镍、拉丝镍、仿金、古铜、枪黑、喷漆
Finish: Chrome, Matt Chrome, Matt Nickel, Bushed Nickel, Golden, Antique Brass, Gun Black, Painting

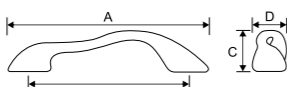

(尺寸) (SIZE)	A	B	C	D
	96	64	22	20
	116	76	19	18

CM 3013



材质: 锌合金
Material: Zinc alloy

表面处理: 光络、哑络、哑镍、拉丝镍、仿金、古铜、枪黑、喷漆
Finish: Chrome, Matt Chrome, Matt Nickel, Bushed Nickel, Golden, Antique Brass, Gun Black, Painting



(尺寸) (SIZE)	A	B	C	D
	141	126	26	26

CM 3014



材质: 锌合金
Material: Zinc alloy

表面处理: 光络、哑络、哑镍、拉丝镍、仿金、古铜、枪黑、喷漆
Finish: Chrome, Matt Chrome, Matt Nickel, Bushed Nickel, Golden, Antique Brass, Gun Black, Painting

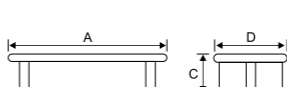

(尺寸) (SIZE)	A	B	C	D
	107	96	12	42

CM 3021



材质: 锌合金
Material: Zinc alloy

表面处理: 光络、哑络、哑镍、拉丝镍、仿金、古铜、枪黑、喷漆
Finish: Chrome, Matt Chrome, Matt Nickel, Bushed Nickel, Golden, Antique Brass, Gun Black, Painting



CM 3022



材质: 锌合金
Material: Zinc alloy

表面处理: 光络、哑络、哑镍、拉丝镍、仿金、古铜、枪黑、喷漆
Finish: Chrome, Matt Chrome, Matt Nickel, Bushed Nickel, Golden, Antique Brass, Gun Black, Painting



(尺寸) (SIZE)	A	B	C	D
	111	96	23	9

CM 3015



材质: 锌合金
Material: Zinc alloy

表面处理: 光络、哑络、哑镍、拉丝镍、仿金、古铜、枪黑、喷漆
Finish: Chrome, Matt Chrome, Matt Nickel, Bushed Nickel, Golden, Antique Brass, Gun Black, Painting



(尺寸) (SIZE)	A	B	C	D
	110	96	22	9

CM 3016



材质: 锌合金
Material: Zinc alloy

表面处理: 光络、哑络、哑镍、拉丝镍、仿金、古铜、枪黑、喷漆
Finish: Chrome, Matt Chrome, Matt Nickel, Bushed Nickel, Golden, Antique Brass, Gun Black, Painting

CM 3038



材质: 锌合金
Material: Zinc alloy

表面处理: 光络、哑络、哑镍、拉丝镍、仿金、古铜、枪黑、喷漆
Finish: Chrome, Matt Chrome, Matt Nickel, Bushed Nickel, Golden, Antique Brass, Gun Black, Painting

CM 3039

- 材质: 锌合金
Material: Zinc alloy
- 表面处理: 光络、哑络、哑镍、拉丝镍、仿金、古铜、枪黑、喷漆
Finish: Chrome, Matt Chrome, Matt Nickel, Bushed Nickel, Golden, Antique Brass, Gun Black, Painting



CM 3040

- 材质: 锌合金
Material: Zinc alloy
- 表面处理: 光络、哑络、哑镍、拉丝镍、仿金、古铜、枪黑、喷漆
Finish: Chrome, Matt Chrome, Matt Nickel, Bushed Nickel, Golden, Antique Brass, Gun Black, Painting



CM 3041

- 材质: 锌合金
Material: Zinc alloy
- 表面处理: 光络、哑络、哑镍、拉丝镍、仿金、古铜、枪黑、喷漆
Finish: Chrome, Matt Chrome, Matt Nickel, Bushed Nickel, Golden, Antique Brass, Gun Black, Painting

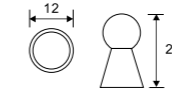

CM 3028

- 材质: 锌合金
Material: Zinc alloy
- 表面处理: 光络、哑络、哑镍、拉丝镍、仿金、古铜、枪黑、喷漆
Finish: Chrome, Matt Chrome, Matt Nickel, Bushed Nickel, Golden, Antique Brass, Gun Black, Painting

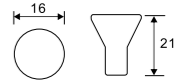

CM 3029

- 材质: 锌合金
Material: Zinc alloy
- 表面处理: 光络、哑络、哑镍、拉丝镍、仿金、古铜、枪黑、喷漆
Finish: Chrome, Matt Chrome, Matt Nickel, Bushed Nickel, Golden, Antique Brass, Gun Black, Painting



CM 3042

- 材质: 锌合金
Material: Zinc alloy
- 表面处理: 光络、哑络、哑镍、拉丝镍、仿金、古铜、枪黑、喷漆
Finish: Chrome, Matt Chrome, Matt Nickel, Bushed Nickel, Golden, Antique Brass, Gun Black, Painting

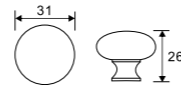

CM 3023

- 材质: 锌合金
Material: Zinc alloy
- 表面处理: 光络、哑络、哑镍、拉丝镍、仿金、古铜、枪黑、喷漆
Finish: Chrome, Matt Chrome, Matt Nickel, Bushed Nickel, Golden, Antique Brass, Gun Black, Painting

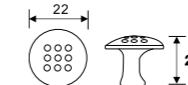

CM 3030

- 材质: 锌合金
Material: Zinc alloy
- 表面处理: 光络、哑络、哑镍、拉丝镍、仿金、古铜、枪黑、喷漆
Finish: Chrome, Matt Chrome, Matt Nickel, Bushed Nickel, Golden, Antique Brass, Gun Black, Painting

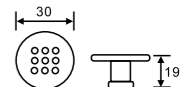

CM 3031

- 材质: 锌合金
Material: Zinc alloy
- 表面处理: 光络、哑络、哑镍、拉丝镍、仿金、古铜、枪黑、喷漆
Finish: Chrome, Matt Chrome, Matt Nickel, Bushed Nickel, Golden, Antique Brass, Gun Black, Painting

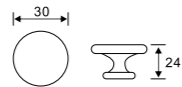

CM 3024

- 材质: 锌合金
Material: Zinc alloy
- 表面处理: 光络、哑络、哑镍、拉丝镍、仿金、古铜、枪黑、喷漆
Finish: Chrome, Matt Chrome, Matt Nickel, Bushed Nickel, Golden, Antique Brass, Gun Black, Painting



A	B	C	D
23		21	14
28		24	17
35		30	21

CM 3025

- 材质: 锌合金
Material: Zinc alloy
- 表面处理: 光络、哑络、哑镍、拉丝镍、仿金、古铜、枪黑、喷漆
Finish: Chrome, Matt Chrome, Matt Nickel, Bushed Nickel, Golden, Antique Brass, Gun Black, Painting



A	B	C	D
27		24	27
33		27	33

CM 3032

- 材质: 锌合金
Material: Zinc alloy
- 表面处理: 光络、哑络、哑镍、拉丝镍、仿金、古铜、枪黑、喷漆
Finish: Chrome, Matt Chrome, Matt Nickel, Bushed Nickel, Golden, Antique Brass, Gun Black, Painting

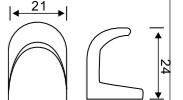

CM 3023

- 材质: 锌合金
Material: Zinc alloy
- 表面处理: 光络、哑络、哑镍、拉丝镍、仿金、古铜、枪黑、喷漆
Finish: Chrome, Matt Chrome, Matt Nickel, Bushed Nickel, Golden, Antique Brass, Gun Black, Painting

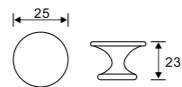

CM 3026

- 材质: 锌合金
Material: Zinc alloy
- 表面处理: 光络、哑络、哑镍、拉丝镍、仿金、古铜、枪黑、喷漆
Finish: Chrome, Matt Chrome, Matt Nickel, Bushed Nickel, Golden, Antique Brass, Gun Black, Painting



A	B	C	D
18		23	
22		28	
24		29	

CM 3027

- 材质: 锌合金
Material: Zinc alloy
- 表面处理: 光络、哑络、哑镍、拉丝镍、仿金、古铜、枪黑、喷漆
Finish: Chrome, Matt Chrome, Matt Nickel, Bushed Nickel, Golden, Antique Brass, Gun Black, Painting

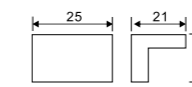

CM 3034

- 材质: 锌合金
Material: Zinc alloy
- 表面处理: 光络、哑络、哑镍、拉丝镍、仿金、古铜、枪黑、喷漆
Finish: Chrome, Matt Chrome, Matt Nickel, Bushed Nickel, Golden, Antique Brass, Gun Black, Painting

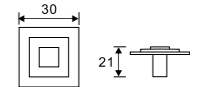

CM 3035



产品材质: 不锈钢 + 锌合金
Material: Stainless steel + Zinc alloy
表面处理: 拉丝
Finish: Stainless steel Brushed

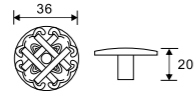

CM 3036

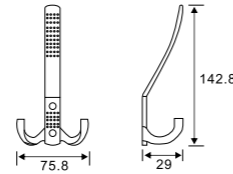

产品材质: 不锈钢 + 锌合金
Material: Stainless steel + Zinc alloy
表面处理: 拉丝
Finish: Stainless steel Brushed



CM 4001

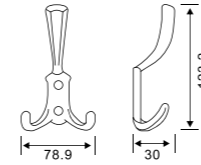

产品材质: 不锈钢 + 锌合金
Material: Stainless steel + Zinc alloy
表面处理: 拉丝
Finish: Stainless steel Brushed



CM 4008

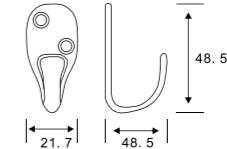

产品材质: 不锈钢 + 锌合金
Material: Stainless steel + Zinc alloy
表面处理: 拉丝
Finish: Stainless steel Brushed



CM 4009



产品材质: 不锈钢 + 锌合金
Material: Stainless steel + Zinc alloy
表面处理: 拉丝
Finish: Stainless steel Brushed

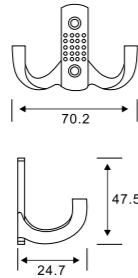

CM 4002



产品材质: 不锈钢 + 锌合金
Material: Stainless steel + Zinc alloy
表面处理: 拉丝
Finish: Stainless steel Brushed

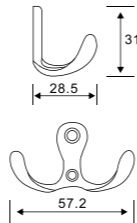

CM 4003

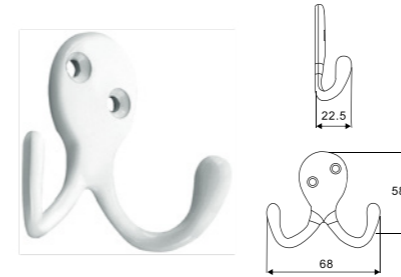

产品材质: 不锈钢 + 锌合金
Material: Stainless steel + Zinc alloy
表面处理: 拉丝
Finish: Stainless steel Brushed

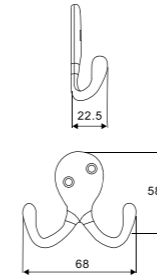

CM 4010



产品材质: 不锈钢 + 锌合金
Material: Stainless steel + Zinc alloy
表面处理: 拉丝
Finish: Stainless steel Brushed

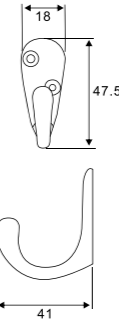

CM 4011



产品材质: 不锈钢 + 锌合金
Material: Stainless steel + Zinc alloy
表面处理: 拉丝
Finish: Stainless steel Brushed

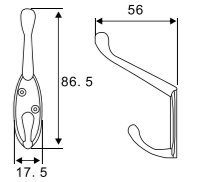

CM 4012



产品材质: 不锈钢 + 锌合金
Material: Stainless steel + Zinc alloy
表面处理: 拉丝
Finish: Stainless steel Brushed

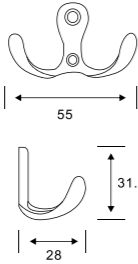

CM 4004



产品材质: 不锈钢 + 锌合金
Material: Stainless steel + Zinc alloy
表面处理: 拉丝
Finish: Stainless steel Brushed

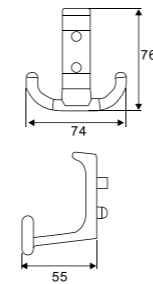

CM 4005

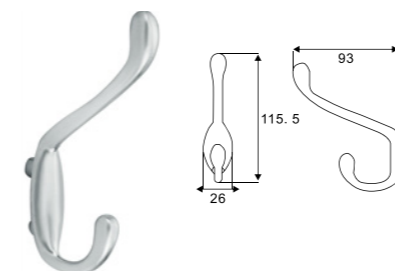

产品材质: 不锈钢 + 锌合金
Material: Stainless steel + Zinc alloy
表面处理: 拉丝
Finish: Stainless steel Brushed

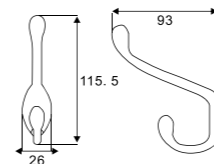

CM 4013



产品材质: 不锈钢 + 锌合金
Material: Stainless steel + Zinc alloy
表面处理: 拉丝
Finish: Stainless steel Brushed

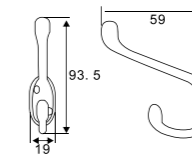

CM 4014



产品材质: 不锈钢 + 锌合金
Material: Stainless steel + Zinc alloy
表面处理: 拉丝
Finish: Stainless steel Brushed

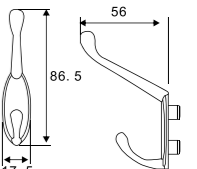

CM 4015



产品材质: 不锈钢 + 锌合金
Material: Stainless steel + Zinc alloy
表面处理: 拉丝
Finish: Stainless steel Brushed

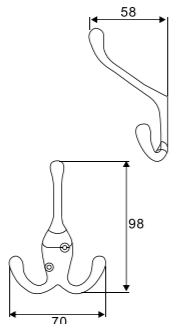

CM 4006



产品材质: 不锈钢 + 锌合金
Material: Stainless steel + Zinc alloy
表面处理: 拉丝
Finish: Stainless steel Brushed

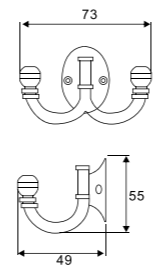

CM 4007

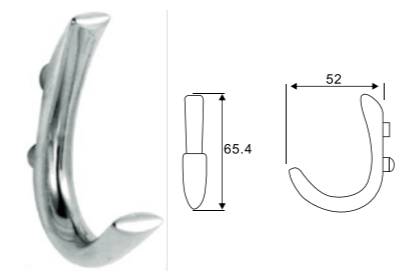

产品材质: 不锈钢 + 锌合金
Material: Stainless steel + Zinc alloy
表面处理: 拉丝
Finish: Stainless steel Brushed

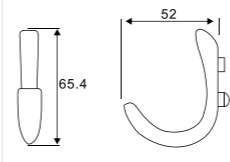

CM 4016



产品材质: 不锈钢 + 锌合金
Material: Stainless steel + Zinc alloy
表面处理: 拉丝
Finish: Stainless steel Brushed

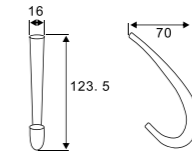

CM 4017

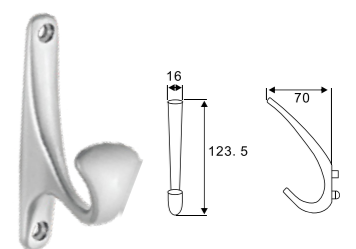

产品材质: 不锈钢 + 锌合金
Material: Stainless steel + Zinc alloy
表面处理: 拉丝
Finish: Stainless steel Brushed

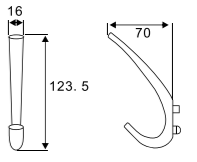

CM 4018